

Marshall

MARSHALL LONDON USER MANUAL

Android™ 5.0 Lollipop

www.marshallphones.com

INDEX

PAGE

007. DEVICE FRONT

008. DEVICE BACK

009. REMOVING THE COVER

010. SIM & MEMORY CARDS

011. INSERTING BATTERY

012. MODE HEADSET

013. SPECIFICATIONS

014. WELCOME TO ANDROID

014. ABOUT ANDROID LOLLIPOP

014. ANDROID AUTO

014. ANDROID WEAR

015. SET UP YOUR DEVICE

016. MAKE YOURSELF AT HOME

016. SEND AN SMS (TEXT MESSAGE) FROM YOUR PHONE

016. MAKE A PHONE CALL

017. MAKE A VIDEO CALL

017. SEND AN EMAIL

017. STATUS BAR

017. QUICK SETTINGS

018. MANAGE BATTERY LIFE

019. GET AROUND

019. BOTTOM NAVIGATION BUTTONS

019. MENUS

020. WELCOME TO ANDROID

020. ORGANIZE YOUR HOME SCREENS

020. TO CHANGE THE WALLPAPER

020. TO ADD AN APP ICON TO A HOME SCREEN

020. TO ADD A WIDGET

020. TO MOVE AN APP OR WIDGET TO ANOTHER POSITION

021. TOUCH & TYPE

021. HELP & SUPPORT

022. ANDROID VERSION & UPDATES

023. ESSENTIALS

023. GOOGLE NOW

023. HOW IT WORKS

023. TRY IT

024. WHAT YOU CAN ASK GOOGLE TO DO FOR YOU

024. TURN “OK GOOGLE” ON OR OFF

025. DISPLAY

025. SOUND & NOTIFICATION

027. MANAGE ACCOUNTS ON YOUR DEVICE

027. ADD AN ACCOUNT

027. REMOVE AN ACCOUNT

028. SHARE YOUR DEVICE WITH OTHER USERS

028. SWITCH USERS

029. REMOVE A USER

029. GUEST USER

029. SECURITY

030. ESSENTIALS

030. SMART LOCK

030. TRUSTED DEVICES AND FACE MATCHING

030. SCREEN PINNING

031. PROTECT AGAINST HARMFUL APPS

031. ANDROID DEVICE MANAGER

032. PRINTING

032. CHROMECAST™

033. FILE STORAGE

033. SCREENSHOTS

034. USE THE KEYBOARD

034. ENTER & EDIT TEXT

034. BASIC EDITING

035. BASIC EDITING

036. EMOJI

036. USE NEXT-WORD SUGGESTIONS

037. GESTURE TYPING

037. USE GESTURE TYPING WITHOUT THE SPACE BAR

037. KEYBOARD DICTIONARIES

037. PERSONAL DICTIONARY

038. ADD-ON DICTIONARIES

038. TYPE BY SPEAKING

039. TRY SOME APPS

039. MARSHALL APPS

039. MARSHALL M-BUTTON APP

039. MUSIC CONTROLLER

039. MARSHALL FEED

039. VOLUME CONTROL

039. EQUALIZER

040. SHORTCUT BUTTONS

040. SIMPLE RECORDER

040. DEFAULT MUSIC PLAYER

041. EDJ DJ APP

041. LOOPSTACK RECORDER

041. ROCKABILLY BROTHERS GAME

042. TRY SOME APPS

042. GOOGLE APPS

042. ALL APPS

042. GMAIL

043. TO ADD ANOTHER EMAIL ACCOUNT TO GMAIL

044. GOOGLE PLAY

044. GOOGLE PLAY SUPPORT

045. CAMERA

046. PHOTOS

046. CONTACTS

047. MESSENGER

048. TRY SOME APPS

048. DELETE MESSAGES

048. DELETE CONVERSATIONS

048. MANAGE CONVERSATIONS

049. HANGOUTS

049. CALENDAR

050. SETTINGS

051. ACCESSIBILITY

052. TROUBLESHOOTING

052. CODE PROMPT WHEN STARTING UP PHONE

052. YOUR DEVICE DISPLAYS NETWORK OR SERVICE ERROR MESSAGES

052. YOUR DEVICE DOES NOT TURN ON

052. THE TOUCHSCREEN RESPONDS SLOWLY OR IMPROPERLY

053. YOUR DEVICE FREEZES OR HAS FATAL ERRORS

053. CALLS ARE NOT CONNECTED

053. OTHERS CANNOT HEAR YOU SPEAKING ON A CALL

053. SOUND ECHOES DURING A CALL

053. CELLULAR NETWORK OR INTERNET OFTEN DISCONNECTS

053. AUDIO QUALITY IS POOR

054. THE BATTERY ICON IS EMPTY

054. THE BATTERY DOES NOT CHARGE PROPERLY

054. THE BATTERY DEPLETES FASTER THAN WHEN FIRST PURCHASED

054. YOUR DEVICE IS HOT TO THE TOUCH

054. TROUBLESHOOTING

054. ERROR MESSAGES APPEAR WHEN LAUNCHING THE CAMERA

054. PHOTO QUALITY IS POORER THAN THE PREVIEW

055. ERROR MESSAGES APPEAR WHEN OPENING MULTIMEDIA FILES

055. ANOTHER BLUETOOTH DEVICE IS NOT LOCATED

055. NO CONNECTION WHEN CONNECTING TO A COMPUTER

055. YOUR DEVICE CANNOT FIND YOUR CURRENT LOCATION

055. DATA STORED IN THE DEVICE HAS BEEN LOST

056. LEGAL NOTICES

DEVICE FRONT

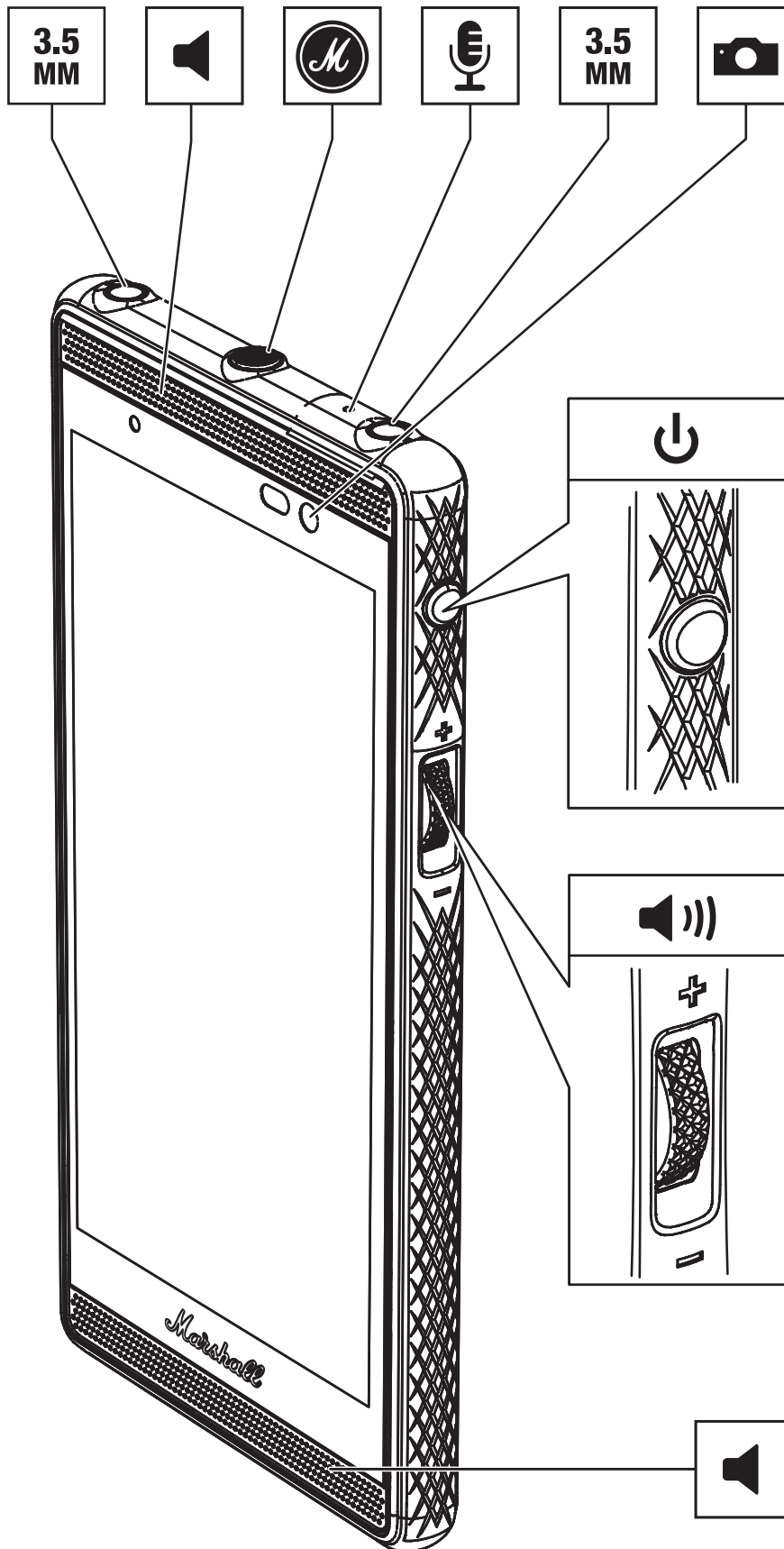

DEVICE BACK

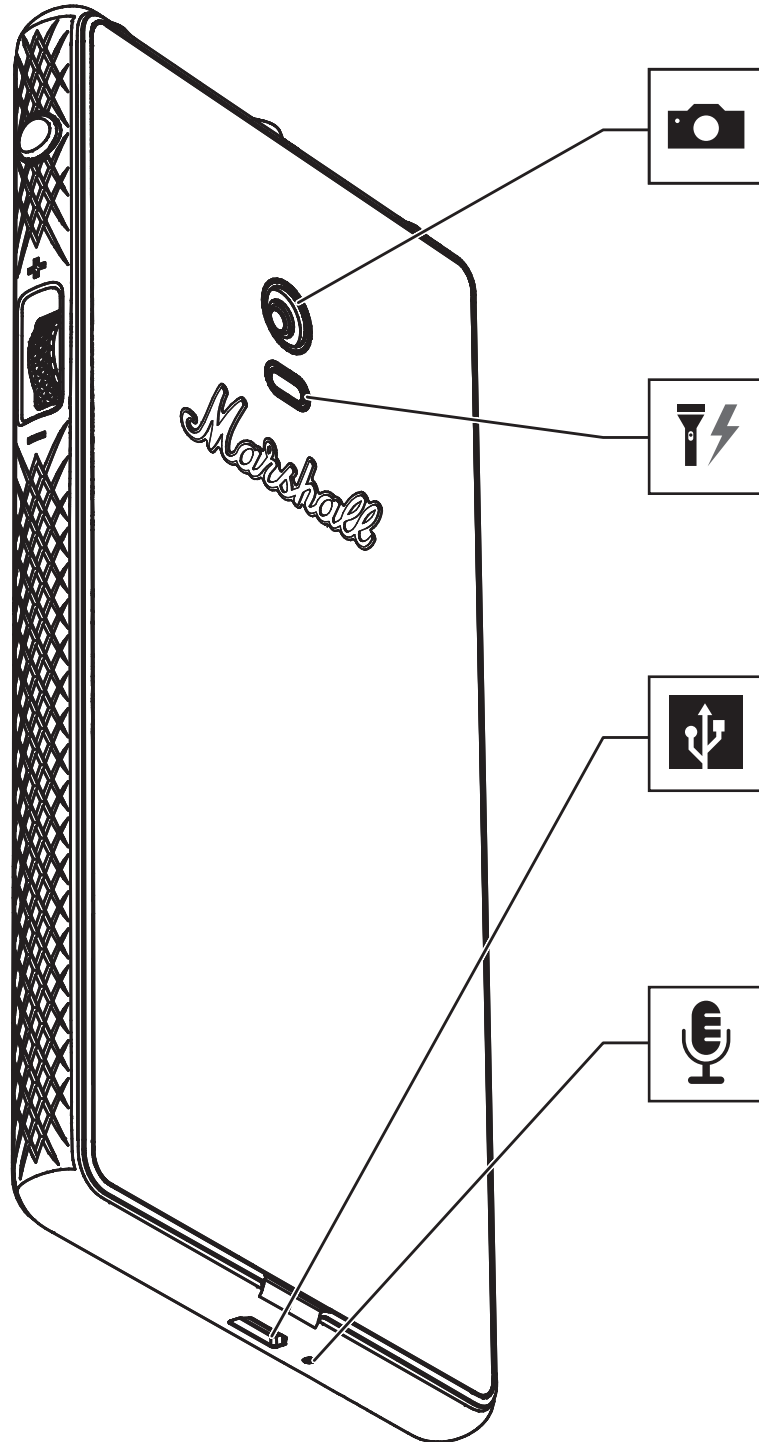

REMOVING THE COVER

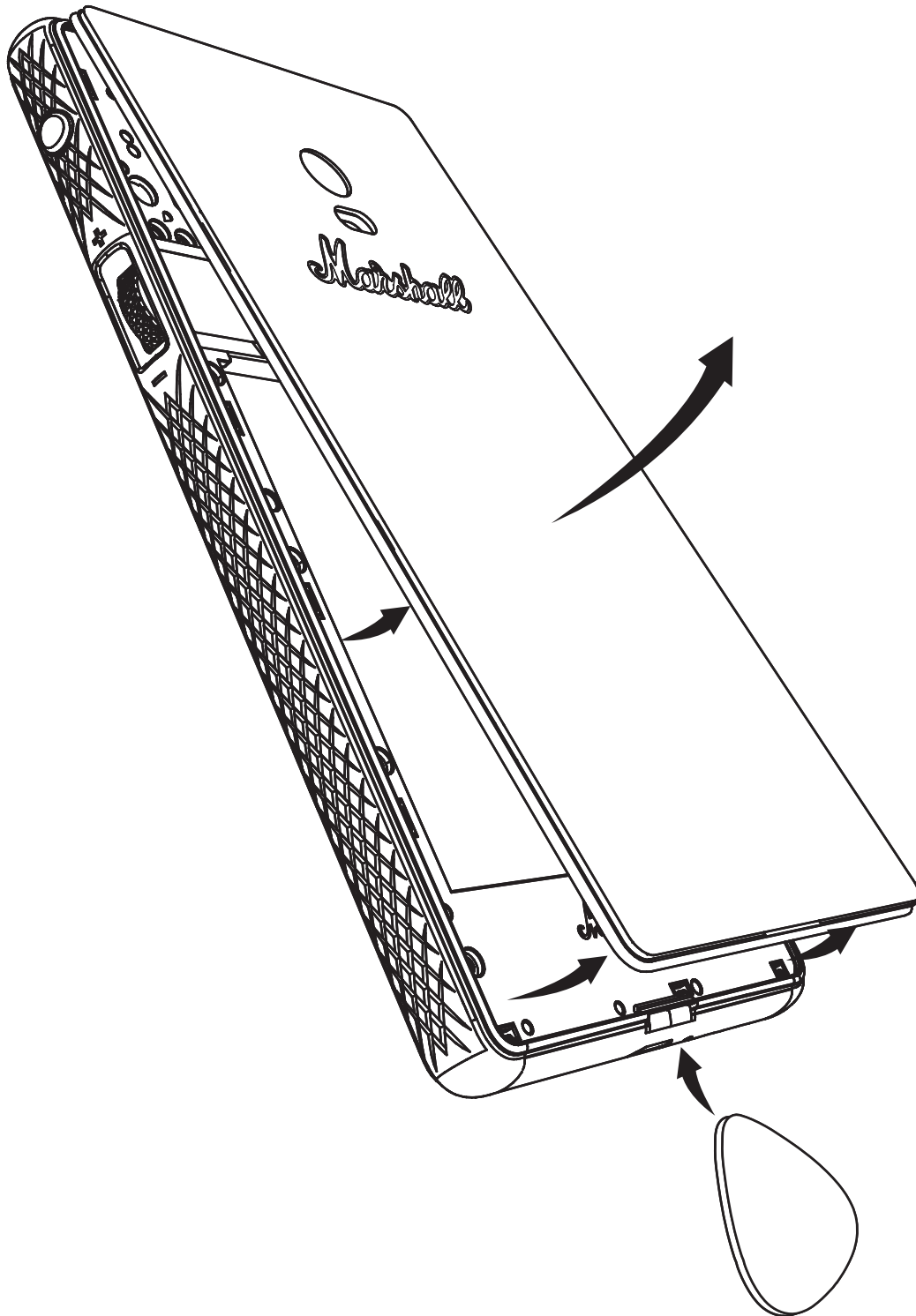

SIM & MEMORY CARDS

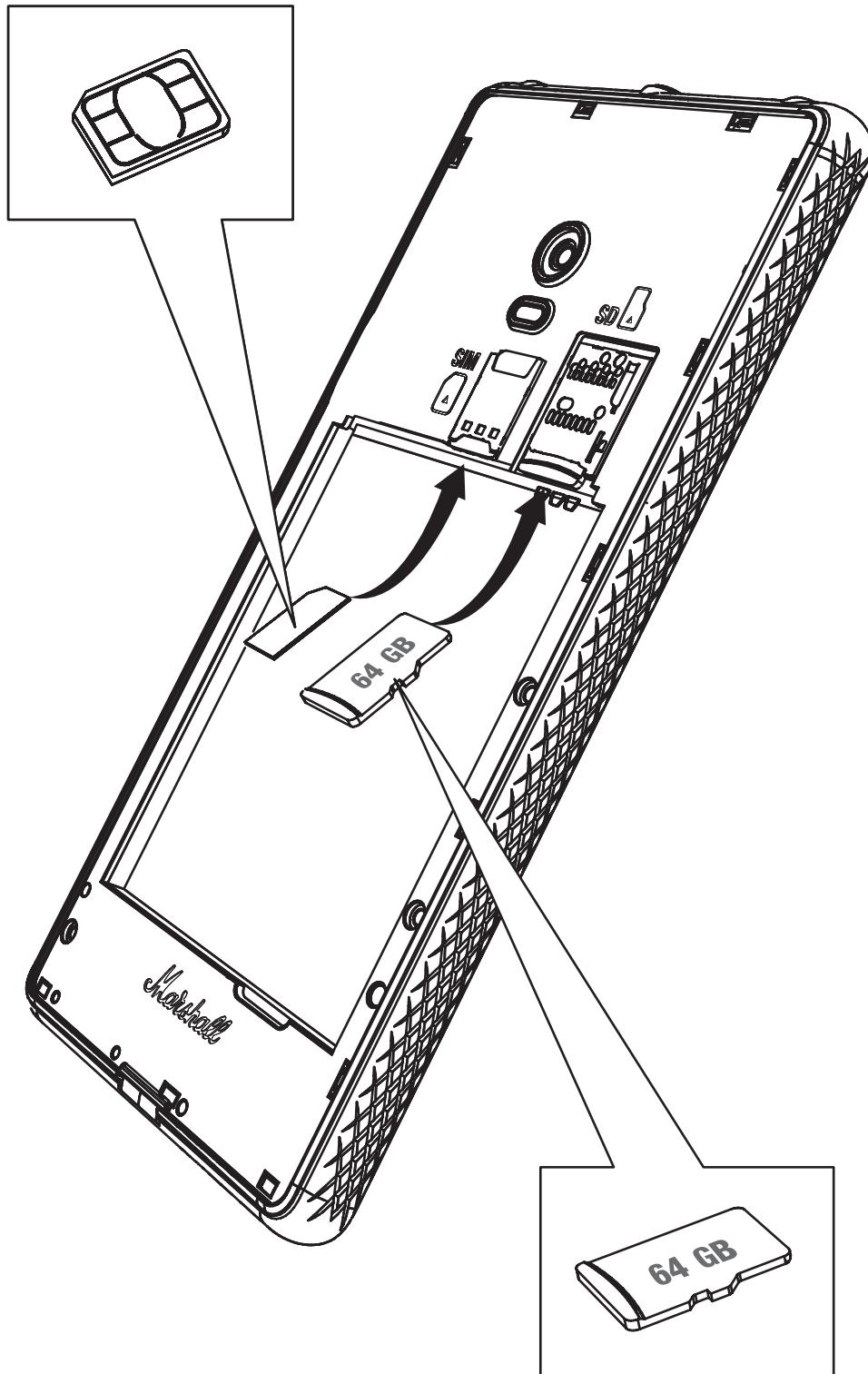

INSERTING BATTERY

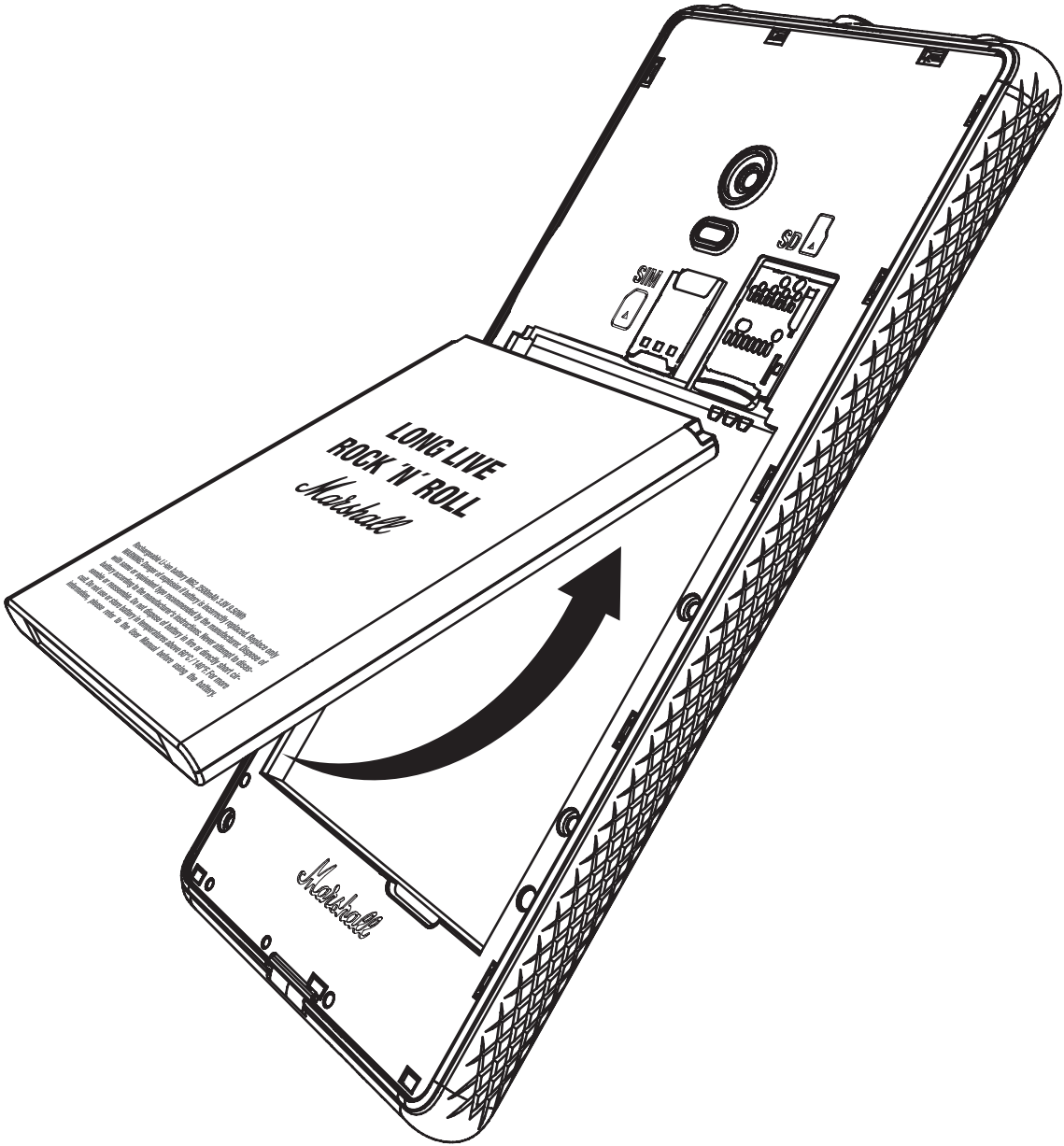

MODE HEADSET

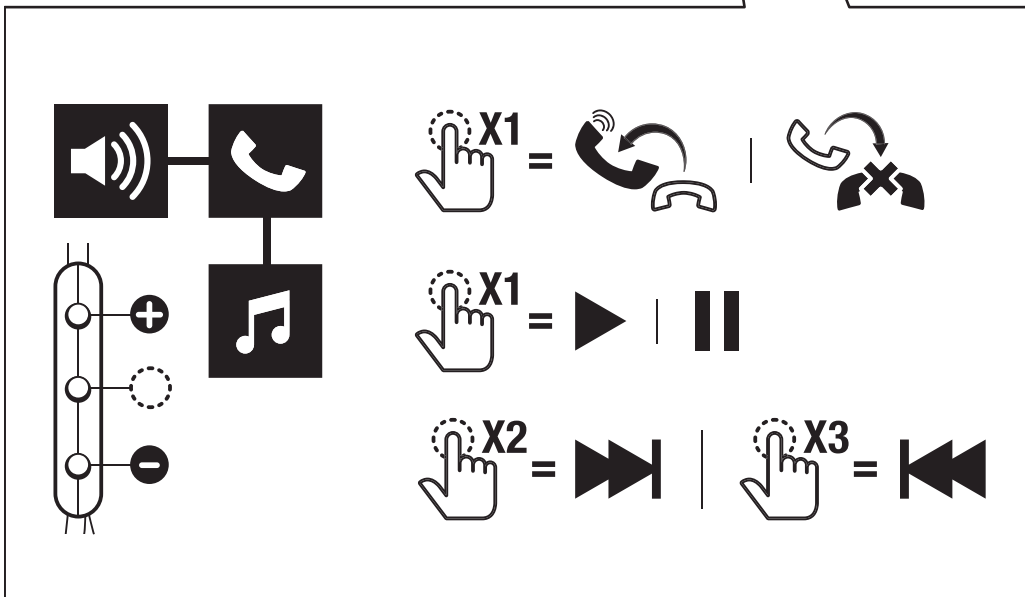
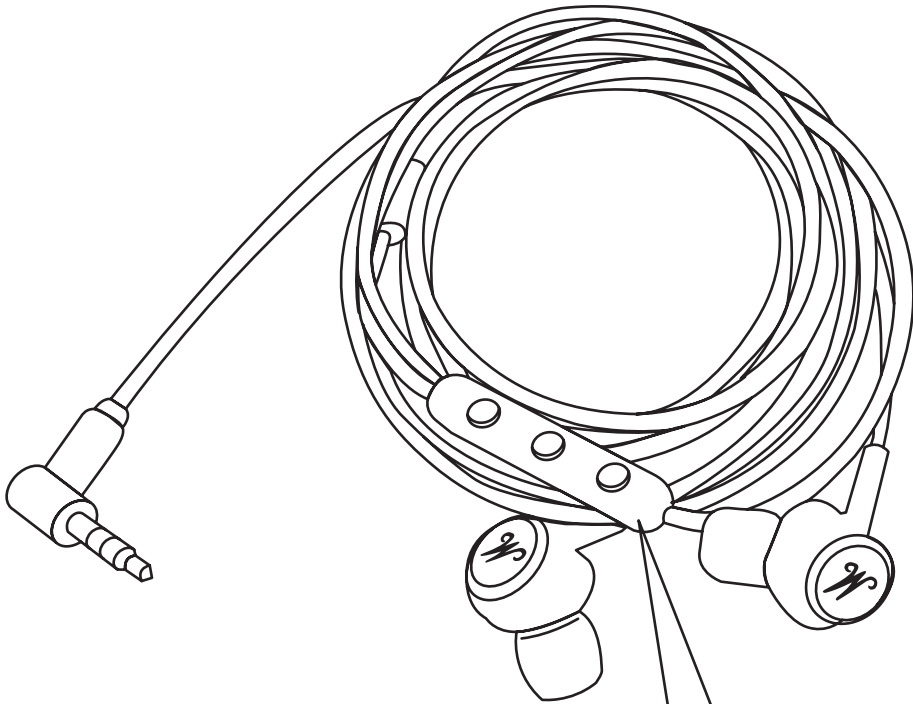

SPECIFICATIONS

CHIPSET	Qualcomm MSM8916
OS	Android 5.0.2, Lollipop
NETWORKS	GSM: 850/900/1800/1900 MHz WCDMA: B1(2100), B2(1900), B3(1800), B5(850), B8(900) LTE : B3(1800), B7(2600), B20(800)
DISPLAY	Multi-touch 4.7" IPS 720P, Gorilla® Glass 3 with anti-fingerprint coating
MEMORY	2GB RAM
BUILT-IN STORAGE	16GB*
EXTERNAL STORAGE	MicroSD™ card slot supporting cards up to 64GB**
WI-FI	a/b/g/n Wi-Fi™ 2.4GHz / 5GHz
BLUETOOTH	Dual Mode Bluetooth™ 4.0 Smart ready
LOCATION	Assisted GPS and Glonass
CAMERAS	8 MP AF main camera with flash, 2 MP front camera
CONNECTORS	Nano SIM, MicroSD™, Micro USB, 2 x 3.5mm audio connectors
SENSORS	ALS, Proximity, Accelerometer, Gyro & E-Compass
SPEAKERS	Two front-facing 13mm x 18mm speakers with enhanced cavity volume & bass
AUDIO	Cirrus Logic™ WM8281 Audio Hub
MICROPHONES	Stereo microphones with active noise cancellation
EXT. CONTROLS	Volume wheel, dedicated "M-button", Power button
NOTIFICATION	Multi-colour notification light, haptic feedback with vibration
BATTERY	Removable 2500mAh Li-ion
DIMENSIONS	149.4 x 74.7 x 9.8mm
WEIGHT	145 grams
*	Some of this space is taken up by the OS and system apps
**	128GB+ support coming soon via firmware update

WELCOME TO ANDROID

ABOUT ANDROID LOLLIPOP

Android Lollipop is the latest version of Android, the operating system that powers not just phones and tablets, but also wearables, TVs, and even cars.

This guide introduces the Android Lollipop software available on your phone. For hardware details for these devices, such as how to insert a SIM card, specs, and so on, visit support.google.com/android. There, you can find comprehensive information about all types of Android phones and tablets, including more details about Google Play™ edition devices and other versions of Android.

Android Lollipop features a bold and bright new design, 3D graphics support that are as good as on a desktop computer, and great new features that make your phone work for you:

- Add guest users and other users without providing them access to your email, contacts, and whatever else you don't want to share.
- Set priorities for notifications and see them when your phone is locked.
- Easier ways to manage battery usage, including a battery saver feature to extend battery life.
- More ways to secure your phone.

ANDROID AUTO

Android Auto will be supported by most major car manufacturers starting with 2015 models. It allows you to plug in your phone to display your music, contacts, and messages on the car's built-in screen. With a simplified interface, integrated steering wheel controls, and powerful new voice actions, it's designed to minimize distraction so you can stay focused on the road. It's easy to get where you're going with free voice-guided navigation via Google Maps™, live traffic information, lane guidance, and more.

For more information, visit android.com/auto.

ANDROID WEAR

Android Wear™ watches from LG, Motorola, Sony, and other manufacturers connect your phone to your wrist. Pause, play, and skip music tracks or quickly respond to text messages using only your watch. Android Wear organizes your information, suggests what you need, and shows it to you before you even ask. Get messages from your friends, meeting notifications, and weather updates at a glance.

For more information, visit play.google.com/store/devices.

WELCOME TO ANDROID

SET UP YOUR DEVICE

When you first turn on your phone, you'll see a Welcome screen. Choose the language you want and touch the arrow to continue.



IMPORTANT: TO COMPLETE THE SETUP PROCESS, IT'S BEST TO HAVE A WI-FI CONNECTION.

When prompted, sign in with your Google™ Account or create one at that time. Signing in lets you immediately access everything associated with your Google Account, like Gmail™. If you prefer, you can skip this step and create an account later.



TIP: IF YOU HAVE BACKED UP A PREVIOUS ANDROID DEVICE WITH THE SAME ACCOUNT, THEN YOU CAN CHOOSE TO RESTORE ANY GOOGLE ACCOUNTS AND APPS THAT WERE ALREADY BACKED UP to AUTOMATICALLY BE COPIED OVER TO THE YOUR DEVICE.

An email address that you use for any of the following counts as a Google Account:

- Gmail
- YouTube™
- Google Play
- Google Apps™
- Any other Google product

Signing in with a Google Account helps you get up and running quickly. When you sign in, you can easily get all the apps you've purchased on Google Play onto your new device. All the email, contacts, calendar events, and other data associated with that account are automatically synced with your device.

For example, if you change a friend's phone number on your phone, that change also appears on your tablet and on any computers where you're signed in to your Google Account.

If you have multiple Google Accounts, you can add others later from

- ⚙ Settings > Personal > Accounts. You can also add guest users in
- ⚙ Settings > Device > Users.

WELCOME TO ANDROID





MAKE YOURSELF AT HOME

After you finish setting up your device, the Home screen appears for the first time. Here, you can add app icons and widgets (an “at-a-glance” view of an app’s most important information) to your Home screens to easily find them.

- To move between Home screens, swipe left or right.
- To see notifications, swipe down from the top of the screen with one finger.
- Open Quick Settings—frequently used settings—swipe down from the top of the screen twice with one finger or once with two fingers. See [“Quick Settings”](#).
- To open  Settings, swipe down from the top of any screen with two fingers or swipe twice with one finger, then touch in the top right.
- From the Home screen, touch Google at the top of the screen, or say “Ok Google” to search and start telling Google what to do.

SEND AN SMS (TEXT MESSAGE) FROM YOUR PHONE

To send an SMS from your phone:

1. Touch  Messenger on your Home screen.
2. Touch  to create a new message.
3. At the top of the screen, enter a phone number or select a contact, then touch . Type your message, then touch .



You can also get the Messenger app on [Google Play](#). You can also use the default SMS app that comes on the phone.

To change your default messaging app, go to  Settings > Wireless & networks > More > Default SMS app.

MAKE A PHONE CALL

Using your phone, you can place calls from the Phone app, the Contacts app, or other apps or widgets that display contact information. Wherever you see a phone number, you can usually touch it to dial.

To place a call to one of your contacts:



1. Touch  Phone on a Home or  All Apps screen.
2. To choose someone to call, scroll or search. If the keypad is in the way, touch the Back button to lower it.
3. To place a call, touch the contact’s name.

To view recent calls, touch the Recents tab. To use the keypad, touch the  keypad.



For more details, visit [Use your phone](#).

WELCOME TO ANDROID

MAKE A VIDEO CALL

The Hangouts™ app lets you send and receive video calls. To open it, touch  Hangouts on a Home or  All Apps screen.

To start a video call:

1. Touch  Add at the top of the main Hangouts screen and start typing a name, email address, or phone number. Matching names and numbers from your contacts appear as you type.
2. Choose a name, then touch  Video at the top of the screen.

To adjust notification preferences and other settings, touch:  Menu > Settings.

For more details, visit [Hangouts help](#).

SEND AN EMAIL

Use the Gmail app to read and write email from your Gmail or other email addresses.

Touch  Gmail on a Home or  All Apps screen.



1. If you already signed into a Gmail account during setup, your email will be synced to your device. Otherwise, add an email address now.

STATUS BAR

The status bar is at the very top of the screen. On the right, you can see the Wi-Fi and mobile signal strength, how much battery power is left, and the time. On the left, you can see which apps have sent you notifications. See [“Sound & notification”](#).

QUICK SETTINGS

Use Quick Settings to easily get to frequently used settings, like turning on airplane mode. To open Quick Settings, swipe down from the top of the screen with two fingers or twice with one finger. To change a setting, just touch the icon:

- Wi-Fi network:  Turn Wi-Fi on or off. To open Wi-Fi settings, touch the Wi-Fi network name.
- Bluetooth settings:  Turn Bluetooth on or off. To open Bluetooth settings, touch the word “Bluetooth”.
- Cellular data:  See cellular usage data and turn it on or off.

WELCOME TO ANDROID

- Airplane mode: ✈ Turn airplane mode on or off. Airplane mode means your phone won't connect to Wi-Fi or a cell signal, even if one is available.
- Flashlight: 🔦 Turn the flashlight on or off.
- Display brightness: ⚙ Slide to lower or increase the brightness of your screen.
- Auto-rotate: 🔄 Lock your device's orientation in portrait or landscape mode.

On your phone, Quick Settings look like this:

Open the main Settings app by touching ⚙ Settings in the top right.

You can also turn 🔄 Auto Rotate on or off from Quick Settings, to lock or unlock automatic screen rotation.

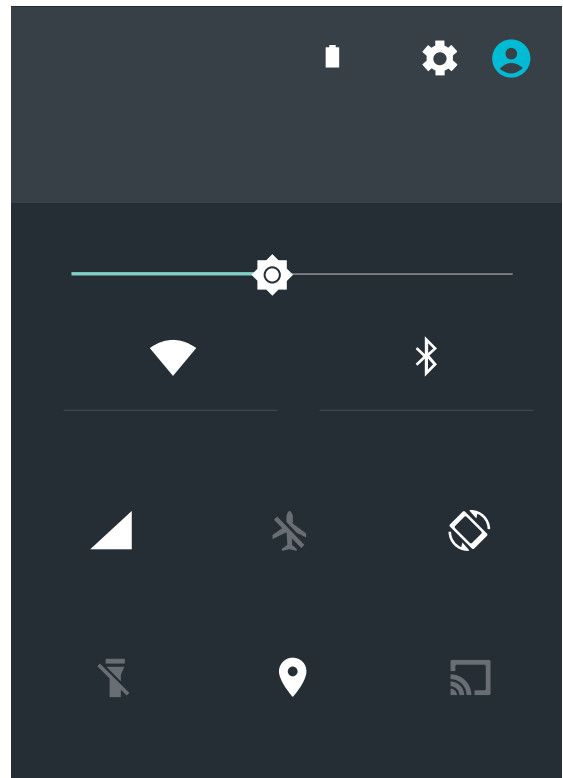

MANAGE BATTERY LIFE

The status bar shows how much battery you have left, but you can also see the exact percentage and approximate time of battery life remaining. Swipe down from the top of the screen, then touch 🔋 Battery.

Your battery is built to get you through your day. When you're running low, Marshall London's battery saver conserves your battery power so you can still make calls and send SMS (text) messages. To turn it on, go to ⚙ Settings > Battery > Battery saver.

For more information, visit [Manage battery life](#).

WELCOME TO ANDROID

GET AROUND

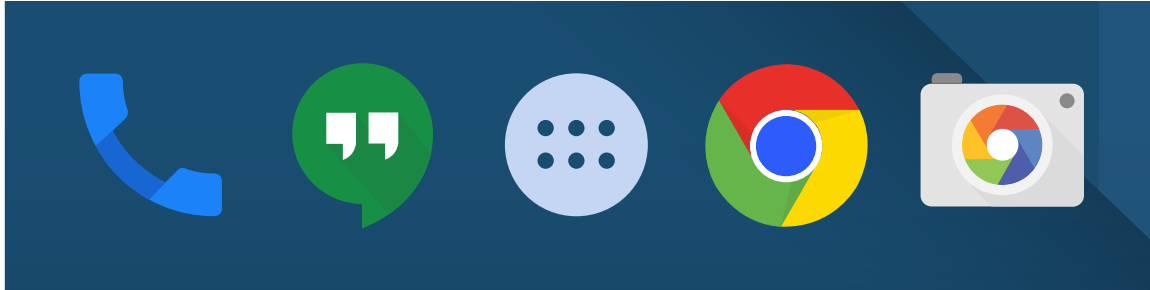

At the bottom of every Home screen you'll find the Favorites tray: another quick way to get to your apps.



To open an app, touch it. To drag an app in or out of the Favorites tray or anywhere else on a Home screen, touch & hold it, then move it with your finger where you want it.

BOTTOM NAVIGATION BUTTONS

At the bottom of the phone, no matter what you're doing, you'll always find the navigation bar with three buttons. On your phone, it looks like this:

	BACK Opens the previous screen you were working in, even if it was in a different app. Once you back up to the Home screen, you can't go back any further.
	HOME Opens the central Home screen. To open Google Now™, swipe up.
	OVERVIEW Opens a list of thumbnail images of screens you've worked with recently. To open one, touch it. To remove a screen from the list, swipe it left or right or touch on the X.

Some apps hide these buttons temporarily, or fade them to small dots in the same position. To bring them back, touch the dots, touch the screen in the middle, or swipe up from the bottom.

MENUS

Many screens in Apps and in Settings include a  Menu icon at the top right of the screen. Touch it to explore additional options, including Help and Settings.

WELCOME TO ANDROID

ORGANIZE YOUR HOME SCREENS

- To change your wallpaper, add a widget, adjust Search settings, or change screen order, touch & hold the background of any Home screen.
- You can have any number of Home screens to the right. To add a new screen, swipe to the rightmost screen and drag an app or widget to the right edge.
- The screen to the left of the main Home screen is reserved for Google Now, and is available only when Google Now is turned on.
- To create a folder, slide one icon quickly on top of another.
- To name or rename a folder, open it and touch its name.

TO CHANGE THE WALLPAPER

1. Touch & hold the background, then touch  Wallpapers.
2. Swipe right to left to choose a wallpaper image. Or choose an image from your Photos, Downloads or Drive.

TO ADD AN APP ICON TO A HOME SCREEN

1. Go to the Home screen where you want to place the app.
2. Touch  All Apps.
3. Swipe from right to left, if necessary, to find the app you want.
4. Touch & hold the app until the Home screen appears, slide it into place, and lift your finger.

TO ADD A WIDGET

1. Touch & hold the background, then touch Widgets. Open All Apps > Widgets.
2. Swipe right to choose a widget, which provides a quick view or way to access information on your home screen, like a larger size clock or a view of information in your Google Play library.

TO MOVE AN APP OR WIDGET TO ANOTHER POSITION

1. Touch & hold the icon.
2. Slide your finger to the new position.
 - To move between Home screens, slide toward the edge of the screen.
 - To bump another icon out of the way, slide slowly into it.
3. Lift your finger.

WELCOME TO ANDROID

TOUCH & TYPE



To select or activate something, touch it.

To type something, such as a name, password, or search terms, just touch where you want to type. A keyboard pops up that lets you type into the field.

Other common gestures include:

- **Touch & hold.** To select an item, touch & hold it by not lifting your finger until something happens. This is how you access accent and other special characters on the keyboard. Slide your finger to the accented letter you need.
- **Touch, hold, & drag.** Touch & hold an item for a moment and then, without lifting your finger, move your finger on the screen until you reach the target position. You can move apps around on the Home screen.
- **Swipe or slide.** Quickly move your finger across the surface of the screen, without pausing when you first touch (so you don't drag something instead). Slide a Home screen left or right to view the other Home screens.
- **Double-tap.** Tap quickly twice on a map or image to zoom in and out.
- **Scale.** In some apps (such as Maps, Chrome™, and Photos), you can scale by placing two or more fingers on the screen at once and pinching them together (to enlarge scale) or spreading them apart (to reduce it).
- **Rotate the screen.** The orientation of most screens rotates with your device as you turn it. To keep your screen locked in Portrait mode, swipe down with two fingers from the top of any screen and touch  Portrait/Auto-Rotate in Quick Settings.

HELP & SUPPORT

For most Google apps, you can get to help and support from the  Menu. Other apps include a  Menu icon that you can touch.

This guide introduces just a few of the key features and apps that come with Android 5.0. For more details about Android software and apps available on [Google Play](https://play.google.com), and all forms of support, visit support.google.com/playedition.

Google also welcomes feedback from you about your phone. It's easy to send your feedback. Just go to  Settings > About phone > Send feedback about this device.

WELCOME TO ANDROID

ANDROID VERSION & UPDATES

To check your version number or get the latest system update for your phone, first go to  Settings > System > About phone. Then look for these labels:

- System updates. Touch to check whether you have any pending system updates.
- Android version. Look partway down the list for this heading and the number just below it.

For comprehensive online help and support, including details about Google Play edition hardware running the software described in this manual and links to information about other Android devices, visit support.google.com/android.

ESSENTIALS

GOOGLE NOW

Google Now is about getting you just the right information, at just the right time. It tells you today's weather before you start your day, how much traffic to expect before you leave for work, and even your favorite team's score while they're playing.

After you start using Google Now, you don't need to do anything else. If you like, you can fine-tune some settings, but Google Now doesn't need any elaborate setup.

HOW IT WORKS

To know when to show information you'll find useful, Google Now uses contextual data from your device and from other Google products, plus data from third-party products that you allow Google Now to access. For example, if you have an appointment in Google Calendar™ that includes an address, Google Now can check traffic and suggest when to leave.

When you decide to use Google Now, you're also turning on Location Reporting and Location History:

- Location Reporting allows Google to periodically store and use your device's most recent location data in connection with your Google Account. Location Reporting is a per-device setting.
- Location History allows Google to store a history of your location data from all devices where you're logged into your Google Account and have turned on Location Reporting.

You can control how Google Now uses your current location. To view the relevant settings, go to  Settings > Personal > Location. When location services are turned on for your account on a given device, certain apps can use them to give you more relevant information, such as nearby restaurants or commute traffic.

To learn more about how Google Now uses your location and other information, visit [About Google Now](#).

TRY IT

You have a chance to turn on Google Now when you first set up your device. You can also turn it on or off at any time:



1. Touch & hold any empty space on your Home screen.
2. Go to  Settings > Google Now.

ESSENTIALS

To open Google Now, swipe up from the Home button. Updates appear in the form of Google Now cards. When you don't need a card anymore, swipe it from left to right. Swiping from right to left returns you to the main Home screen.

When you want to see more cards, touch More at the bottom of the screen.

To adjust the way certain cards get updated:

- Manage reminders: From the ☰ Menu at the top left of the screen, touch  Reminders.
- Request updates for your sports teams, stocks, and more: From the ☰ Menu, touch  Customize.
- Customize other updates: At the top right of each card, touch the ⋮ three dots.

For more details, visit [About Google Now](#). For a complete list of cards available, visit google.com/now.

WHAT YOU CAN ASK GOOGLE TO DO FOR YOU

When you use Google Now, you can speak to your device to search, get directions, and create reminders. For example, say “Ok Google, do I need an umbrella tomorrow?” to see if there's rain in the weather forecast.

To see other examples of what you can say, visit [“Ok Google” and voice search](#). You can say most of these examples in English, French, German, Italian, Japanese, Korean, Russian, Spanish, and Brazilian Portuguese, but some examples aren't available in every language.



If you want to say “Ok Google” in languages other than English, you also need to change the main language on your device. Visit [Change your language on Google](#).

TURN “OK GOOGLE” ON OR OFF



You can start a search or task by saying “Ok Google.” To turn it off or on, open Google Now or the Google app and touch Menu > Settings > Voice > OK Google detection.

DISPLAY

Change the display settings on your device by following these steps:

1. Go to  Settings > Device > Display.
2. Choose from the following settings. Some of these settings may vary by your device and version of Android. All can affect battery life. See [“Manage battery life”](#) on page 18 for more information.
 - Brightness level: Move the  slider to set the brightness level on your device.
 - Adaptive brightness: Turn on adaptive brightness to automatically optimize the brightness level on your device based on the available light around you. Adaptive brightness is on by default. You can still adjust your brightness when needed.
 - Sleep: Change how long it takes for your device’s screen to go black when you’re not using it. Learn more about [Sleep Settings](#).
 - Daydream: Set up screensavers that display photos, colorful backgrounds, and more when your device is charging or docked. Learn more about using [Daydream](#).

SOUND & NOTIFICATION

You can change the sound and notification settings on your device by going to  Settings > Device >  Sound & notification.

Notifications alert you to the arrival of new messages, calendar events, and alarms, as well as ongoing events, such as downloads:

- Interruptions. Prioritize sound notifications so they don’t interrupt you. Touch the settings to turn phone call and message interruptions on or off. If you turn Messages notifications on, touch Calls/messages from to specify from whom you accept notifications (Anyone, Starred contacts or Contacts Only). In Downtime, select which days and times you allow for sound notifications.
- When device is locked. Manage whether notifications can be seen when your phone is locked, and whether sensitive content in a notification can be seen. Sensitive content includes things like the title of a song you downloaded, who sent you an email, or the details of a calendar event. For more information, visit the [Help Center](#).
- App Notifications. Modify the notification settings individually for apps such as Gmail. The setting under ‘When device is locked’ will always take precedence over the setting for an individual app.
- Notification access. See which apps can access your notifications.

ESSENTIALS

When a notification arrives, its icon appears at the top of the screen. Icons for pending notifications appear on the left, and system icons showing things like the Wi-Fi signal, mobile carrier signal, or battery strength are on the right:

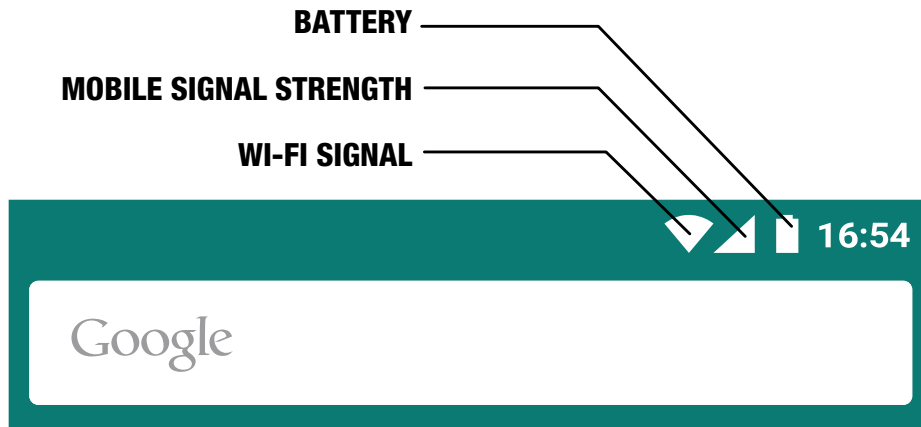

TIP: WI-FI AND MOBILE SIGNAL STRENGTH ARE INDICATED AT THE TOP OF THE SCREEN BY WHITE BARS. TO SEE WHETHER THE SELECTED WI-FI NETWORK HAS A FULL INTERNET CONNECTION, OPEN QUICK SETTINGS BY SWIPING DOWN WITH TWO FINGERS FROM THE TOP OF THE SCREEN.

IN QUICK SETTINGS ONLY, WHITE BARS IN THE WI-FI OR MOBILE SIGNAL INDICATORS INDICATE THE SIGNAL STRENGTH OF A NORMAL INTERNET CONNECTION.

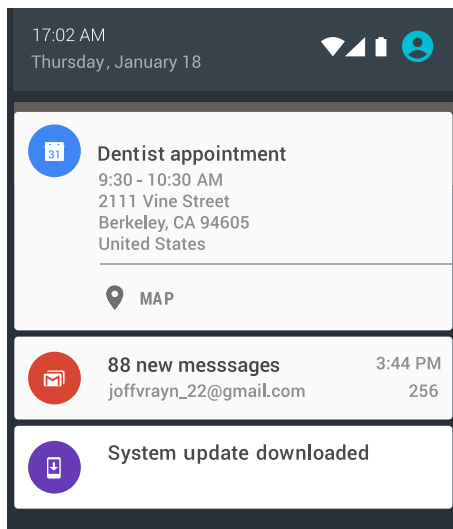

Certain notifications can be expanded to show more information, such as email previews or calendar events.

The one at the top is always expanded when possible. To expand a notification, position one finger inside it and swipe down slowly.

To open the related app, touch the notification icon on the left. Some notifications also allow you to take specific actions by touching icons within the notification. For example, Calendar notifications allow you to Snooze (remind you later) or send email to other guests.

When you're finished with a notification, swipe it away. To dismiss all notifications, touch  Dismiss at the very bottom of the notifications list.

ESSENTIALS

MANAGE ACCOUNTS ON YOUR DEVICE

You can add accounts so that information associated with that account automatically syncs with your device. You'll need to set up an account on your device if you want to get email or get apps on Google Play.

You can also [add multiple users](#) for your device. Adding users is different from adding accounts. Each user has separate settings and can't access the accounts of other users, whereas a single user can have multiple accounts and switch between them anytime they're signed in.

Make sure you're signed in as the correct user before adding or removing any account information.

ADD AN ACCOUNT

1. Go to  Settings > Personal > Accounts. Touch "Add account."
 - i. Touch the type of account you want to add. You may be able to choose from choices like "Google," "Personal (IMAP)," or "Personal (POP3)." If you're not sure whether to choose IMAP or POP3, try IMAP first. Many email services use IMAP. [Learn more about the differences between IMAP and POP3.](#)
 - ii. Choose "Google" if you want to add your Google Account. When you sign in with a Google Account, all the email, contacts, calendar events, and other data associated with that account are automatically synced with your device.
 - iii. Follow the on-screen instructions to add the account.

To change the settings of any of the accounts you added, follow these steps:

2. Go to  Settings > Personal > Accounts.
3. Select your account. If you're using a Google Account, touch Google and then your account.



REMOVE AN ACCOUNT

When you remove an account that you've added to your device, everything associated with that account, including email, contacts, and settings is also deleted. You can't remove the account you used to initially set up your device.

To remove an account from your device, follow these steps:

1. Check to see if the account you want to remove is the account you used to set up your device.
 - If it's not, go to step 2 and follow the instructions.

ESSENTIALS

- If it is, reset your device to its factory settings instead of following the steps below. This erases all of the data from your device and you'll need a Google Account to set up your device again. Learn how to do a factory data reset on your [Google Play edition device](#).
2. Open the  Settings menu on your device.
 3. Under "Accounts," touch the name of the account you want to remove. If you're using a Google Account, touch Google and then the account.
 - When you sign out of your Google Account, all the email, contacts, Calendar events, and other data associated with that account will no longer automatically sync with your device.
 4. Touch  Menu in the top right corner of the screen.
 5. Touch Remove account.

SHARE YOUR DEVICE WITH OTHER USERS

You can easily share your device with family and friends by creating a separate user for each person. Each person has their own space on the device for custom Home screens, accounts, apps, settings, and more. You must be the device owner to add users.

To add a new user, follow these steps:

1. Go to  Settings > Device > Users.
2. Touch Add user, then touch OK.
 - If you're with the new user: Touch "Set up now" and you'll be taken to the lock screen. Select the new user, unlock the screen, and allow them to set up their Google Account and other details.
 - If the new user isn't around: Touch "Not now." A "New user" will appear in the list. The next time you're with the user, go back to the user list and select "New user" or click the user image on the lock screen.

After a user is set up, when you go to the lock screen, you'll see a second user profile picture or avatar in the status bar. To choose a user, touch the picture and unlock the screen. Each user can [set their own screen lock](#).



SWITCH USERS

To switch users, swipe down from the top of any screen twice to open Quick Settings. Touch the image of the current user in the top right corner of the screen, then touch another user's image.



ESSENTIALS

REMOVE A USER

The device's owner can delete any user that they added:

1. Go to  Settings > Device > Users.
2. Touch  Settings next to the user's name, then touch Remove user.

Other users can only delete their own space.

1. Go to  Settings > Device > Users.
2. Touch  Menu > Delete username from this device.

GUEST USER

If someone wants to temporarily use your device, but they don't need to be set up as a regular user, they can use it as a guest. Guest users don't have access to your mail, your apps, or any content on your device that's tied to your account, like photos or downloaded files. You must be the device's owner to add a guest.

1. Go to  Settings > Device > Users.
2. Touch Guest.

When your guest is finished using your device, you can switch back to another user.

To switch to another user: Swipe down from the top of any screen, and then touch the bar at the top to open Quick Settings. To choose another user, touch the image in the top right corner of the screen, then touch another user's image.

SECURITY

If a lock is set for your screen, the screen goes dark and locks when the display goes to sleep or if you press the Power button.

You can set locks of different strengths using Screen Lock settings:

1. Go to Settings > Personal > Security > Screen lock.
2. Touch the type of lock you'd like to use.

Even when your screen is locked, you can perform certain activities.

- Quick Settings: Slide down from the top of the screen to open Quick Settings without entering your password.
- Camera: Slide from right to left to open the Camera.

ESSENTIALS

- Access Dialer: Slide from left to right to make a phone call. (First you have to enter your password.)
- Emergency Calls: Slide from left to right to make an emergency phone call without having to enter your password.

If you have a device that's set up for more than one user, you may need to touch your image at the bottom of the screen to see your own locked screen.

For more information, visit [Customize the screen lock](#).

SMART LOCK

You can turn on Smart Lock to keep your device unlocked when it's clear that you have it with you—for example, when it's connected to your Bluetooth watch or when it recognizes your face.

TRUSTED DEVICES AND FACE MATCHING

You can set your device to stay unlocked while connected to a Bluetooth device — like a watch, fitness tracker, headset, or car speaker system.

You can also have your device unlock when it recognizes your face. After setting a trusted face, every time you turn on your device, it will search for your face and unlock if it recognizes you. Keep in mind that someone who looks similar to you could unlock your phone.

Note: Face matching doesn't store any photos of you. Data used to recognize your face is only stored on your device and is not accessible by apps or backed up on Google servers.

For more information on how to use these features, see [Trusted devices and face matching](#).





SCREEN PINNING

You can enable your device to only show a certain app's screen using screen pinning. Screen pinning can be handy if you want to play a game without accidentally minimizing the app if you touch the Home button. Some apps may ask you if you want to use screen pinning.

When a screen is unpinned, you can choose to return to the screen where you enter your password or PIN.

ESSENTIALS

To pin a screen:

1. Go to  Settings > Security > Screen pinning and turn screen pinning on.
2. Open an app.
3. Touch  Overview on your device. Swipe up the first screen on the bottom to bring it into view.
4. Touch  the pin. Here, you can select an option to return to the lock screen after a screen is unpinned.
5. To exit from the pinned screen, touch and hold  and  at the same time.

PROTECT AGAINST HARMFUL APPS

Apps from Google Play are always verified by Google to protect you and your device from harm. By default, your device doesn't allow the installation of apps from sources other than Google Play.

If you choose to allow the installation of apps from unknown sources and install apps from sources other than Google Play, it's more likely that apps will be installed that could harm you or your device.



If you allow the installation of apps from unknown sources, the Verify Apps feature protects you when installing apps outside of Google Play by continually checking your device to make sure that all apps installed are behaving in a safe manner, even after installation.

For more information or to change the default behavior, visit [Protect against harmful apps](#).

ANDROID DEVICE MANAGER

If you lose your phone, the Android Device Manager* can help you find its approximate location, make it ring, lock it, or erase its data.

*Coming soon via firmware update.

These options are turned on by default. To view or change them, open the  Google Settings app (found in  All Apps) and touch Android Device Manager.

If you lose your device, go to [Android Device Manager](#) and follow the instructions.

PRINTING

With Android 5.0, you can preview and print the content of certain screens (such as web pages displayed in Chrome) to a printer on the same Wi-Fi network as your Android device.

Before you can print, you need a printing service installed on your device. To check what services are currently available, go to  Settings > System > Printing.

From here, you can open each available service to turn it on or off, check which printers it makes available, add new printers, and adjust the service's settings.

To print a document, such as a webpage in Chrome:

1. Touch  Menu > Print.
2. In the dialog that appears, adjust settings such as printer, copies, orientation, and so on.
3. Touch Print.

CHROMECAST™

Chromecast™ is a small device that plugs into the back of your TV. It allows you to send videos and music straight from your phone to your TV.

You can use Chromecast with apps like:

- YouTube
- Netflix
- Twitch
- Google Play Music
- Hulu Plus

To see more apps, visit chromecast.com/apps.

When using Chromecast, make sure your phone is using the same Wi-Fi network as your Chromecast, and that Chromecast is selected as your TV's source input.

To display content from your phone on your TV:

1. Open the video or music in one of the apps listed above.
2. Touch  Cast.
3. Play the content as usual to stream it to your TV. For more information, see [Cast from apps to your TV](#).

ESSENTIALS

FILE STORAGE

Android 5.0 makes it easy to store and browse through pictures, videos, and other files on your device and attach them to an email, Hangout message, and so on. You can also use stored images as your Home screen wallpaper.



For example, to attach an image to an email you're composing, touch the  Paper Clip in the top right and choose to either Attach file or Insert from Drive to select stored images in your Drive folder.

From here, you can view any of these sources:

- Recent shows you the photos or videos you've taken or opened most recently.
- Drive lets you attach any files stored in Google Drive™.
- Images displays any photos, videos, or other images on your device.
- Downloads includes most files (excluding Play content) you've downloaded from emails or the Web
- Photos lets you browse all the images and videos that are on your device or have been uploaded to your Google account.

Use the Downloads app to view, reopen, or delete files you download from Gmail or other sources (excluding Google Play books, videos, magazines, and other media.)

In the Downloads app:

- Touch an item to open it.
- In your list of downloads, touch & hold an item to select it. Touch  Share and choose a sharing method from the list. Touch  to delete.

Google Play streams purchases and rentals via the Internet. So the purchases and rentals don't always occupy storage space when you play them. Although you can download content in Google Play apps to access offline, Google Play content never appears in Downloads.

SCREENSHOTS

To take a screenshot:

1. Make sure the image you want to capture is displayed on the screen.
2. Press the Power button and Volume wheel down simultaneously. The screenshot is automatically saved in your Photos.



TIP: TO EASILY SHARE YOUR SCREENSHOT VIA GMAIL, GOOGLE+, AND MORE, SELECT YOUR SCREENSHOT IN PHOTOS AND TOUCH SHARE AT THE BOTTOM. TOUCH  EDIT TO MODIFY. TOUCH  TO DELETE. FOR GOOGLE PLAY EDITION DEVICES, TOUCH  SHARE.

USE THE KEYBOARD



TIP: TO SELECT A KEYBOARD LANGUAGE OTHER THAN ENGLISH, GO TO  SETTINGS, PERSONAL > LANGUAGE & INPUT. FOR MORE DETAILS, VISIT THE [KEYBOARD HELP](#).

ENTER & EDIT TEXT

Use the onscreen keyboard to enter text. Here's what it looks like on your phone:

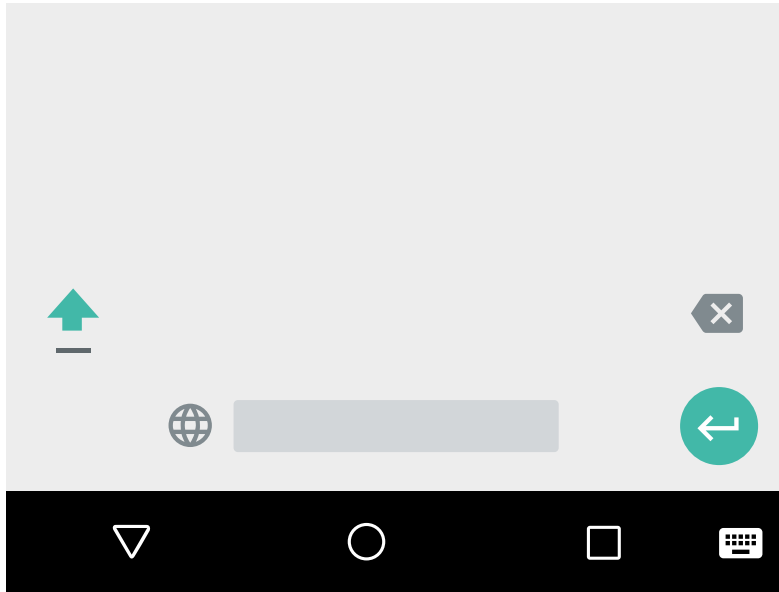















Some apps open the keyboard automatically. In others, you first need to touch where you want to type.

BASIC EDITING

CHANGE WHERE YOU WANT TO TYPE	Touch the cursor, then touch and drag the tab that appears below it to the new position.
SELECT TEXT	Touch and hold or double-tap within the text. The nearest word highlights, with a tab at each end of the selection. Drag the tabs to change the selection.
DELETE TEXT	Touch the  Delete key to delete the characters before the cursor or selected text.

USE THE KEYBOARD

BASIC EDITING

TYPE CAPITAL LETTERS	<p>To switch to capital letters for one letter, touch the  Shift key once.</p> <p>You can also touch and hold the  Shift key while you type or you can touch the  Shift key and slide to another key.</p> <p>When you release the key, the lowercase letters reappear.</p>
TURN CAPS LOCK ON	<p>Double-tap or touch and hold the  Shift key so that it changes to . Touch the  Shift key again to return to lowercase.</p>
CHANGE WORD CAPITALIZATION	<p>If you want to quickly change the capitalization of a word you've already typed, you can select it and touch the  Shift key.</p> <p>You'll have the option to select the capitalized word or the word in all capital letters.</p>
TYPE A SYMBOL OR CHARACTER	<p>To switch to symbol keys for one word, touch the symbol key  once.</p> <p>You can also touch and hold the symbol key  while you type or you can touch the symbol key  and slide to another key.</p> <p>When you release the key, the letter keys reappear.</p>
VIEW MORE SYMBOLS AND CHARACTERS	<p>Touch and hold symbols or characters to get accented characters or additional symbols</p>
CUT, COPY, PASTE	<p>Select the text you want to cut or copy. Then touch the Cut button  or Copy button . To paste, touch the space where you want to paste your text and then touch Paste . If you want to replace other text with the text you copied, highlight the text, then touch the Paste button .</p>

USE THE KEYBOARD

EMOJI

Use Google Keyboard to choose from a variety of small, colorful images used to express emotion (known as emoji) to add some fun to your messages.

Depending on your device, you may need to touch and hold the Return key and then slide your finger to the happy face to display emoji. You'll see a panel like this. To move between categories, swipe left or right or touch the symbols in the top row. To type an emoji, touch it:

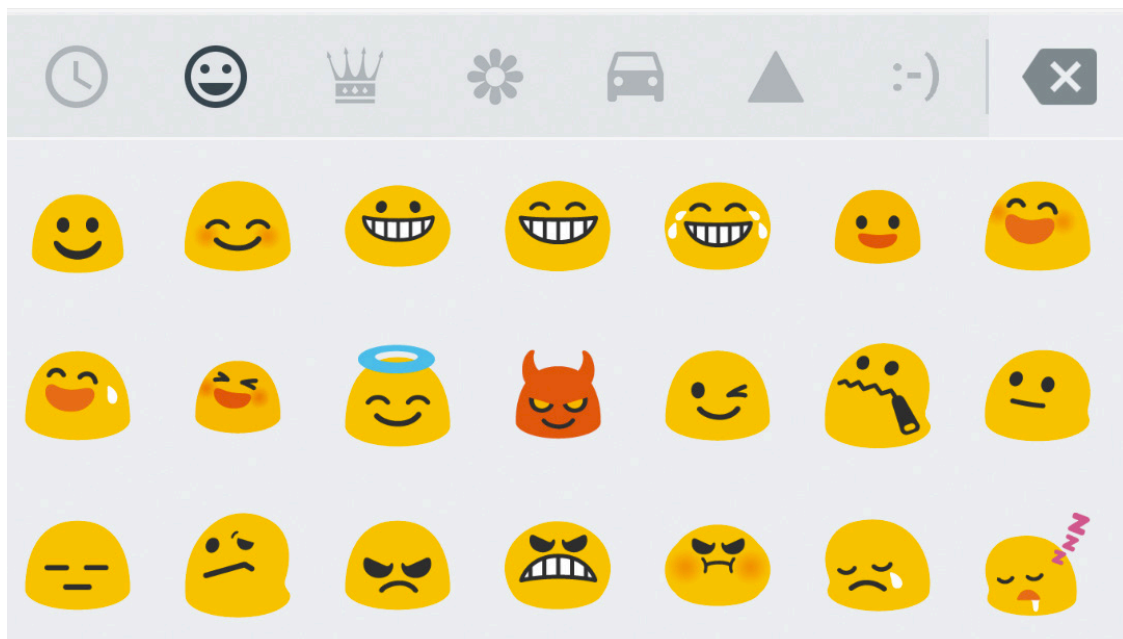

USE NEXT-WORD SUGGESTIONS

1. Touch the location where you want to input text.
2. Start typing out a word. When the word you want is displayed in a list above the keyboard, touch it.
3. Continue to touch words unless the one you want doesn't appear. If so, type it.

Android continues to suggest words as you type.

To change your keyboard and input methods, go to  Settings > Personal > Language & input.

To turn next-word suggestions on or off, go to  Settings > Personal > Language & input > Keyboard & input methods > Google Keyboard > Text correction > Next-word suggestions.

USE THE KEYBOARD

GESTURE TYPING

Gesture Typing works best for English. Quality varies for other languages, and some don't support it yet.

To input a word using Gesture Typing:

1. Touch the location where you want to type to open the keyboard.
2. Slide your finger slowly across the letters of the word you want to input.
3. Release your finger when the word you want is displayed in the floating preview or the middle of the suggestion strip. To select one of the other words in the suggestion strip, touch it.

If the word you want isn't shown while using Gesture Typing, you can type it out manually. If you gesture a word and want to change it, touch the word to see other choices in the suggestion strip



TIP: IF THERE ARE LETTERS YOU WANT TO EMPHASIZE, LIKE REPEATED LETTERS, SUCH AS THE "E" IN SLEEP, PAUSE OVER THE "E" SLIGHTLY LONGER BEFORE MOVING ON TO THE NEXT LETTER.

USE GESTURE TYPING WITHOUT THE SPACE BAR

When you use Gesture Typing, there's no need to use the space bar — just continue to slide your finger across the letters you want to input, then lift your finger to start the next word.

To change Gesture Typing settings, go to  Settings > Language & input > Keyboard & input methods > Google Keyboard > Gesture Typing.

KEYBOARD DICTIONARIES

To manage keyboard dictionaries, go to  Settings > Personal > Language & input.

PERSONAL DICTIONARY

You can add your own words to your personal dictionary so that your device remembers them. To add a word or phrase, including an optional shortcut, go to  Settings > Personal > Language & input > Google Keyboard > Text Correction > Personal dictionary and the language of the dictionary you want to modify, then choose Add and type in the word. When you use the optional shortcut when typing, your word or phrase appears as an option in the suggested words above the keyboard.

USE THE KEYBOARD

ADD-ON DICTIONARIES

1. Go to  Settings > Personal > Language & input > Google Keyboard > Text Correction > Add-on dictionaries.
2. You'll see dictionaries for other languages that you can download to your device.
3. Touch the dictionary you want, then Install.

TYPE BY SPEAKING

You can speak to enter text in most places where you can enter text with the onscreen keyboard.

1. Touch a text field, or a location in the text you've already entered in a text field.
2. Touch the  Microphone key on the onscreen keyboard.
3. When you see the microphone image, speak what you want to type.

In some languages, you can also enter punctuation by speaking it, like “comma,” “period,” “question mark,” “exclamation mark,” or “exclamation point.” Supported languages include English, French, Italian, German and Spanish.

To improve processing of your voice input, Google may record a few seconds of background noise in temporary memory at any time. This recording remains on the device only temporarily and is not sent to Google.

To change your speech settings, go to  Settings > Personal > Language & input.

TRY SOME APPS

MARSHALL APPS

MARSHALL M-BUTTON APP

The Marshall London comes with a dedicated button at the top of your device that launches a custom interface to give you access to some of the most common music features on your phone. 

MUSIC CONTROLLER

Now you can control your streams and local music from one interface easily accessible by one click of the M-button.

The following can be done:

- Player selection. Select local or streaming player
- Music control. Play / Pause selected tracks
- More info. Get access to artist information where available
- Host player. Go to host player for more controls

MARSHALL FEED

Get all the latest Marshall news and information specifically for Marshall London users & customized for your region.

VOLUME CONTROL

If you have more than one headset or headphone connected then you can control the individual outputs.

- Set volume. You can adjust the volume for the individual audio outputs. The second volume slider will only appear if a second headphone or headset is connected. When using the volume scroll wheel, you will adjust both outputs at once.
- Mute. You can easily mute and unmute the volume.

EQUALIZER

Adjust equalizer settings for most of your music streams. Some music players and VOIP applications will not be affected by these settings.

The equalizer comes with pre-installed settings that can be managed from the Equalizer+ default music player installed on your phone.

TRY SOME APPS

SHORTCUT BUTTONS

Buttons at the bottom of the interface gives you access to other Marshall Apps as well as handy toggles such as Bluetooth and other system shortcuts. Slide left and right to reveal more buttons.

SIMPLE RECORDER

A simple audio recorder is included to give you quick access to the stereo microphones.

- Recording control. Start, play & pause your recording.
- Save recording. At the end of your session you will be asked to save the file.
- Level feedback. See from the volume meter when things are too soft or too loud.
- Recordings. Access and play back your previous recordings.

DEFAULT MUSIC PLAYER

An advanced music player is included with your phone. The equalizer function is integrated with the same equalizer found in the M-Button App. Management of your custom frequency presets are managed here.

- Bass boost. Enhances the volume of your bass output.
- Visualizer. Watch your sound spectrum move. You can choose among from various audio visualizations.
- DJ mode. Ensures a smooth mix of music.
- Frequency presets. 10 presets are available as well as top option to save your own customized frequency presets.

The available presets are:

- Acoustic
- Classical
- Dance
- Electro
- Flat
- Hip-Hop
- Jazz
- Pop
- R&B
- Rock

TRY SOME APPS

DJ APP

An advanced DJ app that takes advantage of the dual audio outputs of your phone. Using a set of headphones or a headset on one output and connecting to external speakers using the other output will offer the best DJ experience.

Features include:

- 2 Broadcast channels to mix 2 tracks at once
- BPM detection and direct visualization
- Ultra-concise scratch
- Pre-Cueing
- 4 editable Hot Cues
- Loop function
- Tempo function
- 3-band Equalizer and filters available on each channel
- Automix mode

LOOPSTACK RECORDER

Allows you to create tracks and loops using your phones stereo microphones. Multiple channels of loops can be recorded, played-back and merged as required.

Features include:

- 4 independent recordable tracks.
- Combine tracks via drag and drop.
- High quality 44.1 kHz 16-bit recording and processing.
- Control volume and reverb effect per-track.
- Built-in metronome

ROCKABILLY BROTHERS GAME

Help a band of brothers go from zeroes to rock heroes.

TRY SOME APPS

GOOGLE APPS

ALL APPS

To see all your apps, touch  All Apps in the Favorites tray on any Home screen.

This is where you can see all your apps, including those that come with your phone and those you downloaded on Google Play. You can move app icons to any of your Home screens.

From All Apps, you can:

- Move between screens. Swipe left or right.
- Open an app. Touch its icon.
- Place an app icon on a Home screen. Touch & hold the app icon, slide your finger, and lift your finger to drop the icon into your desired Home screen.
- Browse widgets. Touch the Widgets tab at the top of any All Apps screen.
- Get more apps. Touch  Google Play in the list of app icons.

To remove an app icon from the Home screen without removing it permanently from your device, touch & hold it, slide your finger toward the top of the screen, and drop the app over  Remove.



To view info about an app from an All Apps screen, touch & hold it, slide your finger toward the top of the screen, and drop the app over  App Info.



TIP: SOME APPS CAN HARM YOU OR YOUR DEVICE. HOWEVER, YOU DON'T NEED TO PURCHASE ANTI-VIRUS SOFTWARE FOR YOUR PHONE. GOOGLE CAN VERIFY APPS TO HELP PREVENT HARMFUL SOFTWARE FROM BEING INSTALLED.

FOR MORE DETAILS, VISIT [PROTECT AGAINST HARMFUL APPS](#).

EMAIL

Use the Gmail app to read and write email from any mobile device. To open it, touch  Gmail on a Home or  All Apps screen.

Gmail isn't just about email. You can use your Gmail account to sign in to all Google apps and services, including these and many more:

- Google Now, for getting the information you need at just the right time
- Calendar
- People, for keeping track of your contacts
- Google Drive, for working with documents

TRY SOME APPS

While you're reading a message:

- Touch the icons along the top of the screen to archive, throw away, and mark as read. Touch  to mark a message as unread. Look under the Menu to move, change labels, mute, print and do other actions to the email.
- Swipe left or right to read the previous or next conversation.

Organize your conversations: From the Inbox, touch & hold a conversation to select it. Then use the icons and menu along the top of the screen to manage the selected messages.

To change your settings, add an account, or get help, touch the menu icon or button.

No matter where you are in Gmail, you can always get back to the Inbox by touching the  Back button at the top of the screen.

From the Inbox, touch Menu to open the drawer that reveals available accounts, labels, and so on.

For more information, visit [Gmail help](#).



TIP: YOU CAN ACCESS YOUR EMAIL FROM OTHER ACCOUNTS, LIKE MICROSOFT EXCHANGE, IN GMAIL BY ADDING THE ACCOUNT IN GMAIL SETTINGS.

TO ADD ANOTHER EMAIL ACCOUNT TO GMAIL

1. Go to  Settings > Personal > Accounts > Add account.
2. Touch the type of account you want to add. You may be able to choose from choices like “Google,” “Personal,” or “Work.”
3. Choose “Google” if you want to add your Google Account. When you sign in with a Google Account, all the email, contacts, Calendar events, and other data associated with that account are automatically synced with your device.
4. Follow the on-screen instructions to add the account.

To change the settings of any of the accounts you added, follow these steps:

1. Open the  Settings menu on your device.
2. Under “Personal,” touch “Accounts” and select your account. If you're using a Google account, touch Google and then your account.

TRY SOME APPS

GOOGLE PLAY

Google Play brings together all your favorite apps & games, movies & TV shows, books, music, and news & magazines in one place, so you can reach it from any of your devices.

To open the Google Play app, touch  Google Play.



If you purchased content on Google Play in the past, you'll automatically have access to this content on any Android device — just make sure you're signed in using the same account that you used to purchase it.

To check:

1. Open the  Google Play app.
2. Touch  Menu at the top left.

From here, you can view the current account or switch to another, view your purchased apps, check your wish list, and so on.

To set preferences, clear your search history, and turn on user controls, go to  Menu > Settings. For example, to filter apps based on maturity level or require a PIN for purchases, touch Content filtering or Require authentication for purchases.

To find your content, open any of the Google Play apps from the  All Apps screen and touch  Menu.

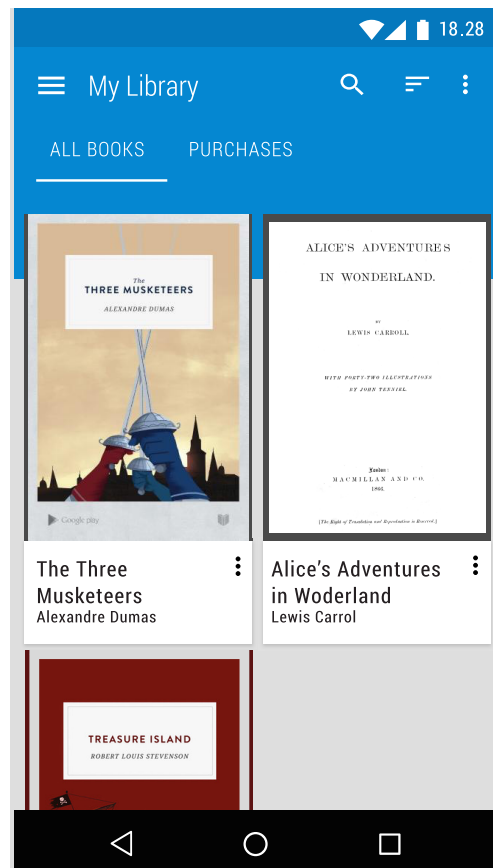

GOOGLE PLAY SUPPORT

For more details about Google Play, including phone and email support options, visit support.google.com/googleplay.

TRY SOME APPS

CAMERA

The Camera app lets you take photos, panoramic photos, videos, and immersive 360-degree photo sphere shots, including what's above and below you.





To open Camera:

- From the lock screen, swipe from right to left.
- From the Home screen, touch  Camera.

The first time you open Camera, you may be asked if you want it to remember photo locations. This allows you, for example, to pinpoint the location of a particular photo with Google Maps.

When you open Camera, you can choose from five different camera modes. To see the modes, swipe left to right.

The  Camera icon indicates Camera mode. To take a picture:

1. Frame your subject and watch for the focus ring.
 - To focus on a different part of the image, touch it. To zoom in, pinch two fingers outwards. To zoom out, pinch two fingers inwards.
2. When the focus ring brackets disappear, touch the shutter button, which is the camera button.
3. To see the image you just took, swipe from right to left. To see stored photos, touch  Photos in the top right. When viewing stored photos, touch  to share,  Edit to modify photos and  to delete.

Keep swiping to see other images in Photos.

To change to a different mode, swipe left to right to show the list of camera modes:

 Camera

Touch Camera to take regular pictures.

 Video

To start recording a video, touch the video button. Touch it again to stop.

To change settings for each mode such as flash, exposure, and so on, touch the circle with the three dots at the bottom right of the framed image.

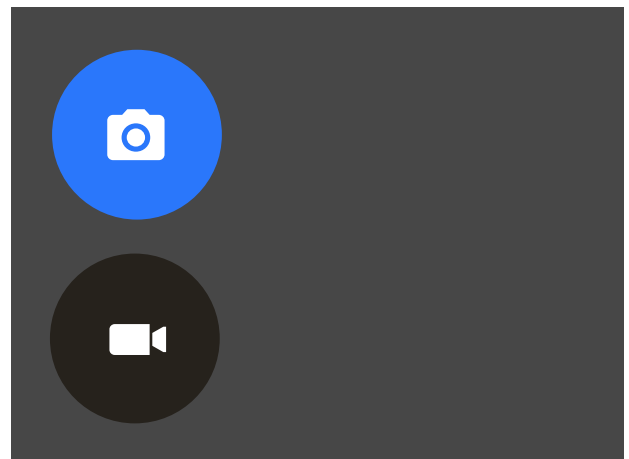

TRY SOME APPS



TIP: HDR AUTOMATICALLY SNAPS A RAPID BURST OF PHOTOS AND COMBINES THEM TO GIVE YOU THE BEST POSSIBLE SINGLE SHOT. TO TURN ON HDR, TOUCH THE S AT THE LOWER RIGHT OF THE SHUTTER AND SELECT HDR.

For more details, visit [Camera help](#).

PHOTOS

The Photos app gives you instant access to all your photos and videos associated with any Google Account set up on your phone. To open it, touch  Photos.

To open Photos from the:
Camera app. Swipe from right to left.
All Apps screen. Touch  Photos.

When you're signed into your device with your Google Account, the Photos app makes it easy to auto-backup all the photos and videos you take, organize them, and share with friends.

You can also browse, search, crop, edit, and tag photos, and create albums and movies.

Touch  Menu to:
Switch to or from Google+.
Organize and edit your photos and videos.
Create and browse albums.
Explore Auto Awesome animations, panoramas, or merged group shots created for you automatically.
Browse photos of yourself.

For more details, visit [Photos help](#).

CONTACTS

The Contacts app gives you quick access to everyone you want to reach. To open it, touch the Contacts icon on a Home or All Apps screen





When you first turn on your device and sign into a Google Account, existing contacts from that account are synced with your Contacts app. After that, your contacts stay in sync automatically on your different devices or a Web browser.

If you use Exchange, you can also sync that contact information with Contacts.

TRY SOME APPS

All your Contacts information is available from Gmail, Hangouts, and other apps. As you add contacts from different sources, they're synced automatically across all the places you need them.

When you open the Contacts app, you can:



- View all contacts or favorites. Choose from the top of the screen.
- Add a contact. Touch  Add Contact.
- Read details. Touch a name to see details for a contact or group.
- Share the contact or place a frequently used contact on the Home screen. Touch  Menu.
- Edit details. While viewing a contact, touch  Edit at the top of the screen to edit the contact's information.
- Change your settings. While viewing the main list screen, touch  Menu to import or export contacts, choose display options and add or edit accounts.

For more information, visit [Contacts](#) help.





MESSENGER

The Messenger app for sending SMS/text messages is available for your phone.



To read and respond to messages, follow these steps:

1. When you receive a new message, you'll get a notification on your device and a new message icon  will appear in your notification panel.
2. To open and read the message, touch the new message notification in the notifications panel.
3. To respond to a message, touch the Send message box and type your message.
4. To send, touch  Send.

To create and send a text message, follow these steps:

1. Go to  All Apps and touch  Messenger.
2. In the main Messenger screen, touch .
3. Enter a name from your contacts or a mobile phone number in the To field. To send a group text message, touch the  group icon in the To field and touch additional contacts or enter additional mobile phone numbers.
 - Below the To field, you can choose from your frequent contacts by touching Frequents or your list of contacts by touching All contacts.
 - If you're sending a group message, make sure you turn on group messaging in Messenger setting.
 - If you choose to enter a name or mobile number in the To field, matching contacts appear as you type, if any exist among your contacts. You can touch a suggested recipient or continue entering the phone number.

TRY SOME APPS

4. To write your message, touch the Send message box and type your message. Learn more about using Google Keyboard and emoji. See [“Use the keyboard”](#).
5. If you touch the  Back button while composing a message, it’s saved as a draft in Messenger. Touch the conversation to resume composing it.
6. To send, touch  Send.

You can manage your messages, conversations, notifications, and contacts right from Messenger home screen. You can also change your sound, notification, and other settings.

DELETE MESSAGES





1. Open a conversation in Messenger.
2. Touch and hold the message you wish to delete.
3. When the “Message options” box appears, touch Delete.

DELETE CONVERSATIONS

1. While viewing your list of conversations in Messenger, touch and hold a conversation to select it.
2. To delete the conversation, touch  Trash in the top right corner of the screen.

MANAGE CONVERSATIONS

From the Messenger home screen, touch and hold a conversation or a selection of conversations to take any of these actions:

- Archive. Touch  Archive to store the conversation.
- Delete. Touch  to delete the conversation from the Messenger app.
- Turn notifications on or off. Touch  Notification to turn notifications on or off for the conversation.
- Add contact. Touch  Add contact to add the conversation’s contact to your list of contacts.

For more information, visit [Messenger help](#).

TRY SOME APPS

HANGOUTS

With Hangouts, you can make video calls to anyone with a Google Account. You can share photos and your location with others. You can also set Hangouts as your default messaging app.

For more information about using Hangouts, visit [Hangouts help](#).

CALENDAR

Use the Calendar app to view and edit your schedule. To open it, touch Calendar on a Home or All Apps screen.

When you first set up your Android device, you have a chance to configure it to use a Google Account (such as Gmail). The first time you open the Calendar app on your phone, it displays any existing calendar events from that Google Account on the web.

As you edit events, they're synced automatically across all the places you need them.

To change the Calendar view, touch the ☰ Menu and choose Schedule, Day, or Week from the top of the screen. From any of these views, you can:

- Read or edit event details. Touch an event to view its details.
- Manage events and calendars. Touch icons across the top of the screen or the menu to search or create events, return to today, or adjust settings.

To email everyone who is invited to an event, you have two options:

- Open the event from the Calendar app at any time and touch Email guests. You have a list of quick responses or you can write your own.
- When a notification of the event arrives just before the meeting starts, swipe down the notification shade. Then swipe using one finger to expand the notification if necessary, and touch Email guests.

For more information, visit [Calendar help](#).

SETTINGS

Settings controls the core Android settings for networks, hardware, location, security, language, accounts, etc.

The fastest way to adjust system settings that you access frequently, such as Wi-Fi or brightness, is through Quick Settings. See [“Quick Settings”](#).

You can control many other settings for your device and account by swiping down from the top of the screen twice and touching . These are the main types of device or account settings available. Click the links to see related help articles.

[Wireless & networks](#). Wi-Fi, Bluetooth, data usage & related settings.

[Device](#). Sound, battery, sleep, and other display settings.

[Location](#).

[Language](#).



[Sync](#).

[Backup/reset options](#).

[Accounts](#).

[Security](#). Passwords and certificates, screen lock, encryption, and app installation sources.

[System](#). [Date, time, accessibility](#), and [device information](#).

Most apps also include their own settings, typically available from the  menu on the upper left side of the app, or from the  Menu > Settings. On Google Play edition devices, settings may be in the Menu button.

Some useful settings are also available from the Google Settings app.

The Google Settings app let you adjust preferences for commonly used Google apps and services in one place, including Google+, Location, Search, and the Android Device Manager.

To open Google Settings, touch the  in  All Apps. From here, you can also:

- Control how interest-based Google ads are displayed in non-Google apps.
- Under Connected apps, you can view all the apps that have access to your Google Account information, including the type of access granted to each app.

ACCESSIBILITY

To use the accessibility options, open  Settings > System > Accessibility.

To view detailed information about setting up these options, visit [Android Accessibility](#). Options for people with visual impairments include the following:

Captions: You can turn on captions for your device and specify the language, text size, and style. For some apps, you have to turn on the captions in the app itself.

TalkBack is a screen reader from Google that comes with your Android phone. It uses spoken feedback to describe events, such as notifications, and the results of your actions, such as opening an app. When TalkBack is on, you have to double-tap in order to select something. TalkBack settings let you control the nature of TalkBack speech, feedback, and touch exploration (Explore by touch).

Explore by touch is a system feature that works with TalkBack, allowing you to touch your device's screen and hear what's under your finger via spoken feedback. It is helpful to people with low or no vision. In TalkBack settings, you can change the settings of Explore by touch, like managing gestures and how lists are scrolled.

Display and sound accessibility options include increasing the text size, changing the speed at which text is spoken, color inversion, color correction, and high contrast text.

If you have low vision and don't plan to use Explore by Touch, visit support.google.com/android to see Help content formatted for sighted users. You can make reading and navigating this material easier by increasing the text size – just open Chrome, go to Menu > Settings > Accessibility, and drag the slider to adjust the text size.

You can also try magnification gestures, which allow you to zoom in and out, as well as temporarily magnify what's under your finger. To try magnification gestures, go to  Settings > Accessibility > Magnification gestures.

TROUBLESHOOTING

Before contacting a service centre, please attempt the following solutions. Some situations may not apply to your device. Please visit <http://www.marshallphones.com> for online support.

CODE PROMPT WHEN STARTING UP PHONE

When you turn on your device or while you are using the device, it prompts you to enter one of the following codes:

- Password: when the device lock feature is enabled, you must enter the password you set for the device.
- PIN: when using the device for the first time or when the pin requirement is enabled, you must enter the pin supplied with the SIM or USIM card. You can disable this feature by using the lock SIM card menu.
- PUK: Your SIM or USIM card is blocked, usually as a result of entering your pin incorrectly several times. You must enter the PUK supplied by your service provider.
- PIN2: when you access a menu requiring the PIN2, you must enter the PIN2 supplied with the SIM or USIM card. For more information, contact your service provider.

YOUR DEVICE DISPLAYS NETWORK OR SERVICE ERROR MESSAGES

- When you are in areas with weak signals or poor reception, you may lose reception. Move to another area and try again. While moving, error messages may appear repeatedly.
- You cannot access some options without a subscription. For more information, contact your service provider.

YOUR DEVICE DOES NOT TURN ON

- When the battery is completely discharged, your device will not turn on. Fully charge the battery before turning on the device.
- The battery may not be inserted properly. Insert the battery again, wipe both gold-coloured contacts and insert the battery again.

THE TOUCHSCREEN RESPONDS SLOWLY OR IMPROPERLY

If you attach a protective cover or optional accessories to the touchscreen, the touchscreen may not function properly.

- If you are wearing gloves, if your hands are not clean while touching the touchscreen, or if you tap the screen with sharp objects or your fingertips, the touchscreen may malfunction.
- The touchscreen may malfunction in humid conditions or when exposed to water.
- Restart your device to clear any temporary software bugs.
- Ensure that your device software is updated to the latest version.

TROUBLESHOOTING

YOUR DEVICE FREEZES OR HAS FATAL ERRORS

If your device freezes or hangs, you may need to close apps or reinsert the battery and turn on the device to regain functionality. If your device is frozen and unresponsive, press and hold the power key and the volume key down simultaneously for more than 7 seconds to restart it.

If this does not solve the problem, perform a factory data reset. On the all apps screen, tap  Settings > backup and reset > factory data reset > reset device > erase everything. Before performing the factory data reset, remember to make backup copies of all important data stored in the device.

CALLS ARE NOT CONNECTED

- Ensure that you have accessed the right cellular network.
- Ensure that you have not set call barring for the phone number you are dialling.
- Ensure that you have not set call barring for the incoming phone number.

OTHERS CANNOT HEAR YOU SPEAKING ON A CALL

- Ensure that you are not covering the built-in microphone.
- Ensure that the microphone is close to your mouth.
- If using a headset, ensure that it is properly connected.

SOUND ECHOES DURING A CALL

Adjust the volume by pressing the volume key or move to another area.

CELLULAR NETWORK OR INTERNET OFTEN DISCONNECTS

- Ensure that you are not blocking the device's internal antenna.
- When you are in areas with weak signals or poor reception, you may lose reception. You may have connectivity problems due to issues with the service provider's base station. Move to another area and try again.
- When using the device while moving, wireless network services may be disabled due to issues with the service provider's network.

TROUBLESHOOTING

THE BATTERY ICON IS EMPTY

- Your battery is low. Recharge or replace the battery.

THE BATTERY DOES NOT CHARGE PROPERLY

- Ensure that the charger is connected properly.
- If the battery terminals are dirty, the battery may not charge properly or the device may turn off. Wipe both gold-coloured contacts and try charging the battery again.

THE BATTERY DEPLETES FASTER THAN WHEN FIRST PURCHASED

- When you expose the battery to very cold or very hot temperatures, the useful charge may be reduced.
- Battery consumption increases when you use messaging features or some apps, such as games or the internet.
- The battery is consumable and the useful charge will get shorter over time.

YOUR DEVICE IS HOT TO THE TOUCH

When you use apps that require more power or use apps on your device for an extended period of time, your device may feel hot to the touch. This is normal and should not affect your device's lifespan or performance.

ERROR MESSAGES APPEAR WHEN LAUNCHING THE CAMERA

Your device must have sufficient available memory and battery power to operate the camera app. If you receive error messages when launching the camera, try the following:

- Charge the battery or replace it with a battery that is fully charged.
- Free some memory by transferring files to a computer or deleting files from your device.
- Restart the device. If you are still having trouble with the camera app after trying these tips, contact a service centre.

PHOTO QUALITY IS POORER THAN THE PREVIEW

- The quality of your photos may vary, depending on the surroundings and the photography techniques you use.
- If you take photos in dark areas, at night, or indoors, image noise may occur or images may be out of focus.

TROUBLESHOOTING

ERROR MESSAGES APPEAR WHEN OPENING MULTIMEDIA FILES

If you receive error messages or multimedia files do not play when you open them on your device, try the following:

- Free some memory by transferring files to a computer or deleting files from your device.
- Ensure that the music file is not digital rights management (DRM)-protected. If the file is DRM-protected, ensure that you have the appropriate licence or key to play the file.
- Ensure that the file formats are supported by the device. If a file format is not supported, such as DIVX or AC3, install an app that supports it.
- Your device supports photos and videos captured with the device. Photos and videos captured by other devices may not work properly.
- Your device supports multimedia files that are authorised by your network service provider or providers of additional services. Some content circulated on the internet, such as ringtones, videos, or wallpapers, may not work properly.

ANOTHER BLUETOOTH DEVICE IS NOT LOCATED

- Ensure that the Bluetooth wireless feature is activated on your device.
- Ensure that the Bluetooth wireless feature is activated on the device you wish to connect to.
- Ensure that your device and the other Bluetooth device are within the maximum Bluetooth range (10 meters).

NO CONNECTION WHEN CONNECTING TO A COMPUTER

- Ensure that the USB cable you are using is compatible with your device.
- Ensure that you have the proper driver installed and updated on your computer.
- If you are a Windows XP user, ensure that you have Windows XP Service Pack 3 or higher installed on your computer.

YOUR DEVICE CANNOT FIND YOUR CURRENT LOCATION

GPS signals may be obstructed in some locations, such as indoors. Set the device to use Wi-Fi or a mobile network to find your current location in these situations.

DATA STORED IN THE DEVICE HAS BEEN LOST

Always make backup copies of all important data stored in the device. Otherwise, you cannot restore data if it is corrupted or lost. Marshall is not responsible for the loss of data stored in the device. This sucks we know, but memory cards do sometimes fail!

LEGAL NOTICES

© 2015 Zound Industries Smartphones AB. All Rights Reserved. Zound Industries Smartphones AB will hereinafter referred to as “Zound Industries”

Marshall, Marshall Amps, their respective logos, “Marshall”, the “Marshall” trade dress as well as corporate and product identity used herein, are trademarks of Marshall Amplification PLC and may not be used without permission.

Parts of this guide is copyrighted © 2015 Google Inc. Google, Google Play and Android are trademarks of Google Inc. A list of Google trademarks is available at <http://www.google.com/permissions/trademark/our-trademarks.html>.



™ 2015 CSR plc and its group companies. The aptX™ mark and the aptX logo are trademarks of CSR plc or one of its group companies and may be registered in one or more jurisdictions.

The Bluetooth® word mark and logos are registered trademarks owned by Bluetooth SIG, Inc.

Wi-Fi® is a registered trademark of the Wireless Fidelity Alliance, Inc.

LTE is a trademark of European Telecommunications Standards Institute (ETSI).

microSD is a trademark of SD-3C LLC.

Microsoft, exFAT, Windows XP and Windows Vista are either registered trademarks or trademarks of Microsoft Corporation in the United States and/or other countries.

Qualcomm is a trademark of Qualcomm Incorporated, registered in the United States, and other countries and used with permission.

Cirrus Logic are among the trademarks of Cirrus Logic, Inc. and its subsidiaries.

All other trademarks and service marks mentioned herein, including company names, product names, service names and logos, are the property of their respective owners and their use herein does not indicate an affiliation with, association with, or endorsement of or by Zound Industries. Not all marks listed necessarily appear in this User Guide.

No part of this document may be reproduced or transmitted in any form or by any means, electronic or mechanical, including photocopying, recording or storing in a retrieval system, or translated into any language in any form without prior written permission of Zound Industries.

LEGAL NOTICES

This guide introduces Android 5.0, Lollipop for the Marshall London. Its content may differ in some details from some of the features described or the software that runs on them. Screen images contained herein are simulated. Zound Industries shall not be liable for technical or editorial errors or omissions contained herein, nor for incidental or consequential damages resulting from furnishing this material. The information is provided “as is” without warranty of any kind and is subject to change without notice. Zound Industries also reserves the right to revise the content of this document at any time without prior notice.

For best results, make sure you’re running the latest Android system update. To find your device’s version number or check for the latest system update, go to  Settings > System > About phone and look for Android version or System updates.

For comprehensive online help and support, including details about Google Play edition hardware running the software described in this manual and links to information about other Android devices, visit support.google.com/android.

Latest version of this manual is available here – <http://phones.marshall.com/london/support/user-manual.pdf>