

# ZenFone 5

e-manual



**ASUS**<sup>®</sup>  
IN SEARCH OF INCREDIBLE

**E8884**

**April 2014**

**First Edition**

# Contents

	<b>Conventions used .....</b>	<b>9</b>
	<b>Care and safety .....</b>	<b>10</b>
	Guidelines.....	10
	Proper disposal .....	11
<b>1</b>	<b>Get your Zen ready!</b>	
	Parts and features .....	14
	Installing a micro-SIM card .....	15
	Installing a memory card .....	20
	Charging your ZenFone.....	24
	Turning your ZenFone on or off.....	27
<b>2</b>	<b>There's no place like Home</b>	
	<b>Zen Home features .....</b>	<b>31</b>
	Home screen.....	31
	Managing your home.....	33
	Quick settings.....	37
	ASUS keyboard settings .....	41
	Voice Search.....	42
	Lock Screen .....	45
	<b>Connecting your ZenFone to your computer .....</b>	<b>46</b>
	Connecting with your notebook.....	46
	Connecting with your desktop PC.....	47
<b>3</b>	<b>Call in style</b>	
	<b>Managing contacts.....</b>	<b>50</b>
	Adding contacts .....	50
	Importing contacts.....	51
	Exporting contacts .....	52

	<b>Making and receiving calls .....</b>	<b>53</b>
	Make a call .....	53
	Receive a call.....	55
	<b>Dual SIM feature .....</b>	<b>56</b>
	Renaming your micro SIM cards.....	56
	Assigning a default micro SIM card.....	57
	<b>Backup/restore call logs.....</b>	<b>58</b>
	Creating a call log backup .....	58
	Restoring call log backups.....	58
<b>4</b>	<b>Send messages and more</b>	
	<b>Messaging .....</b>	<b>60</b>
	Sending or replying to messages.....	60
	Setting up your messaging options.....	61
	<b>Omlet Chat .....</b>	<b>62</b>
	Registering to Omlet Chat .....	62
<b>5</b>	<b>Access your emails</b>	
	<b>Email .....</b>	<b>68</b>
	Setting up an email account.....	68
	Adding email accounts.....	69
	<b>Gmail .....</b>	<b>70</b>
	Setting up a Gmail account.....	70
<b>6</b>	<b>Capture moments</b>	
	<b>Launching the Camera app.....</b>	<b>74</b>
	From the lock screen.....	74
	Using the camera widget.....	74
	From the home screen .....	74
	Using the volume key.....	74

<b>Using Camera for the first time.....</b>	<b>75</b>
Tutorial.....	75
Image Locations .....	76
<b>Camera home screen .....</b>	<b>77</b>
Image settings.....	78
Video settings.....	80
<b>Advanced camera features .....</b>	<b>81</b>
Time Rewind .....	81
HDR.....	82
Panorama.....	82
Night.....	83
Low light.....	84
Selfie .....	85
Miniature.....	86
Smart remove.....	87
All Smiles.....	87
Beautification .....	88
GIF animation .....	88
Depth of field .....	89
Time lapse.....	89
<b>Party Link .....</b>	<b>90</b>
Sharing photos .....	90
Receiving photos .....	92

## **7 Gallery**

<b>Using the Gallery .....</b>	<b>94</b>
Main screen.....	94
Viewing files from other source locations.....	95
Sharing files from the gallery.....	96

Deleting files from the gallery.....	96
Editing an image .....	97
Zooming in/out the thumbnails or an image.....	97

## 8 Work hard, play harder

<b>Supernote.....</b>	<b>100</b>
Creating a notebook.....	102
Sharing a notebook on the Cloud.....	102
Sharing a note to the Cloud .....	102
<b>Calendar .....</b>	<b>103</b>
Creating an event from your ZenFone.....	103
Adding an account to Calendar.....	104
Creating an event from your account.....	104
<b>What's Next .....</b>	<b>105</b>
<b>Do It Later.....</b>	<b>106</b>
Accessing or creating to-do tasks .....	107
<b>Weather .....</b>	<b>108</b>
Weather home screen .....	109
<b>Clock .....</b>	<b>110</b>
Launching Clock.....	110
World Clock .....	111
Alarm clock.....	112
Stopwatch.....	113
Timer.....	114
<b>File Manager .....</b>	<b>116</b>
Accessing the internal storage.....	116
Accessing the external storage device.....	117
Accessing Cloud Storage.....	118

## 9 The Internet

<b>Browser.....</b>	<b>120</b>
---------------------	------------

<b>10</b>	<b>Fun and entertainment</b>	
	<b>Using headset .....</b>	<b>122</b>
	Connecting audio jack .....	122
	<b>Audio Wizard.....</b>	<b>123</b>
	Using Audio Wizard.....	123
	<b>Play Games.....</b>	<b>124</b>
	Using Play Games.....	124
	<b>Music.....</b>	<b>125</b>
	Launching Music.....	125
	Playing songs.....	125
	Playing songs from your SD card .....	125
	Playing Cloud music.....	126
	<b>FM Radio.....</b>	<b>127</b>
	FM Radio home screen.....	127
	<b>Sound recorder .....</b>	<b>128</b>
	Launching Sound Recorder.....	128
	Sound Recorder home screen .....	128
<b>11</b>	<b>Maintain your Zen</b>	
	<b>Keeping your device up-to-date .....</b>	<b>130</b>
	Updating your system.....	130
	<b>Storage .....</b>	<b>130</b>
	<b>Backup and reset .....</b>	<b>131</b>
	<b>Securing your ZenFone .....</b>	<b>132</b>
	Unlocking your screen .....	132
	Setting your ZenFone identity .....	140
<b>12</b>	<b>Connect your Zen</b>	
	<b>Wi-Fi.....</b>	<b>142</b>
	Enabling Wi-Fi.....	142

	Connecting to a Wi-Fi network .....	142
	Disabling Wi-Fi .....	143
	<b>Bluetooth® .....</b>	<b>143</b>
	Enabling Bluetooth® .....	143
	Pairing your ZenFone to a Bluetooth® device.....	144
	Unpairing your ZenFone from the Bluetooth® device.....	144
	Miracast™ .....	145
	<b>Share Link.....</b>	<b>146</b>
	<b>The Cloud .....</b>	<b>148</b>
	ASUS WebStorage.....	148
<b>13</b>	<b>App essentials</b>	
	<b>Switching apps.....</b>	<b>150</b>
	<b>Locking apps .....</b>	<b>150</b>
	<b>Downloading apps .....</b>	<b>151</b>
<b>14</b>	<b>There's more to your Zen</b>	
	<b>Power saver .....</b>	<b>154</b>
	Setting up Power Saver.....	154
	Customizing Power Saver .....	155
	<b>Glove mode .....</b>	<b>156</b>
	<b>ASUS Splendid .....</b>	<b>157</b>
	<b>Appendix</b>	
	<b>Notices.....</b>	<b>160</b>



## Conventions used

To highlight key information in this manual, some text are presented as follows:

---

**IMPORTANT!** This message contains vital information that must be followed to complete a task.

---

---

**NOTE:** This message contains additional information and tips that can help complete tasks.

---

---

**CAUTION!** This message contains important information that must be followed to keep you safe while performing tasks and prevent damage to your ZenFone data and components.

---

# Care and safety

## Guidelines



Road safety comes first. We strongly recommend not to use your device when driving or operating any type of vehicle.



This device should only be used in environments with ambient temperatures between 5°C (41°F) and 35°C (95°F).



Turn off your device in restricted areas where the use of mobile devices is prohibited. Always obey rules and regulations when in restricted areas, such as, in aircraft, movie theater, in hospitals or near medical equipment, near gas or fuel, construction sites, blasting sites and other areas.



Use only AC adapters and cables approved by ASUS for use with this device. Refer to the rating label on the bottom of your device and ensure that your power adapter complies with this rating.



Do not use damaged power cables, accessories, and other peripherals with your device.



Keep your device dry. Do not use or expose your device near liquids, rain, or moisture.



You can put your device through x-ray machines (such as those used in conveyor belts for airport security), but do not expose the device to magnetic detectors and wands.



The device screen is made of glass. If the glass gets broken, stop using the device and do not touch the broken glass parts. Immediately send device for repair to ASUS-qualified service personnel.



Do not listen at high volume levels for long periods to prevent possible hearing damage.



Disconnect the AC power before cleaning your device. Use only a clean cellulose sponge or chamois cloth when cleaning your device screen.



Send device for repair to ASUS-qualified service personnel only.

## Proper disposal



Do not throw your device in municipal waste. This product has been designed to enable proper reuse of parts and recycling. The symbol of the crossed out wheeled bin indicates that the product (electrical, electronic equipment and mercury-containing button cell battery) should not be placed in municipal waste. Check local regulations for disposal of electronic products.



Do not throw the battery in municipal waste. The symbol of the crossed out wheeled bin indicates that the battery should not be placed in municipal waste.



1



***Get your Zen ready!***

1

*Get your Zen ready!*

# Parts and features

Take a hold of your device and have it up and running in a jiffy.

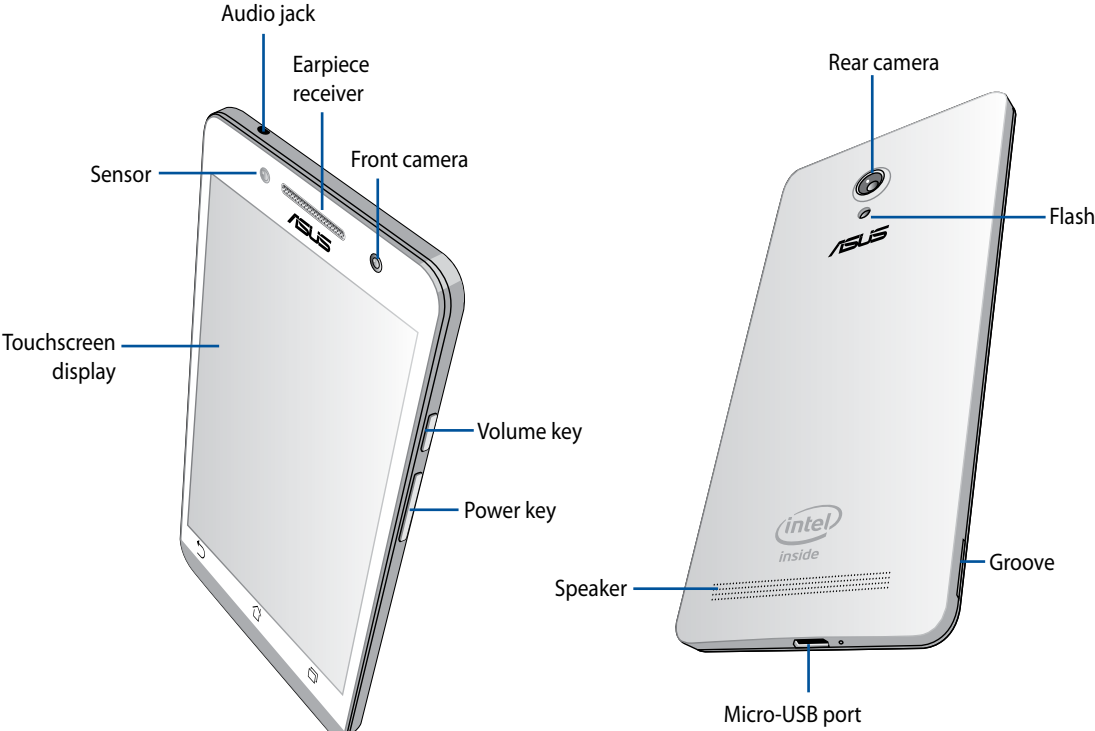

---

**IMPORTANT:**

- We do not recommend using a screen protector as it can interfere with the proximity sensor. If you want to use a screen protector, ensure that it does not block the proximity sensor.
  - Keep the device, particularly the touch screen, dry all the time. Water or other liquids can cause the touch screen to malfunction.
  - Ensure that the Micro-SIM/memory card compartment cover is always closed when operating or carrying the device.
- 

## Installing a micro-SIM card

A micro-subscriber identity module (micro-SIM) card stores information, such as your mobile phone number, contacts, messages and other data that gives you access to a mobile network.

Your ZenFone comes with two micro-SIM card slots that allows you to setup and use two mobile network services without having to carry two mobile devices at the same time.

---

**CAUTION:**

- This device is designed for use with a mobile carrier-approved micro-SIM card only.
  - We do not recommend the use of trimmed SIM cards in the micro-SIM card slot.
  - Turn off your device before inserting a micro-SIM card.
  - Be extra careful when handling a micro-SIM card. ASUS is not responsible for any loss or damage incurred to your micro-SIM card.
  - Do not insert a memory card into the micro-SIM card slot! If a memory card happens to be inserted into the micro-SIM slot, send your device to an ASUS-qualified service personnel.
-

To install a micro-SIM card:

1. Turn off your device.
2. Pry the cover loose from the groove on the bottom-left corner, then pull the rear cover off.

---

**CAUTION!** Be careful when you pry open the cover.

---

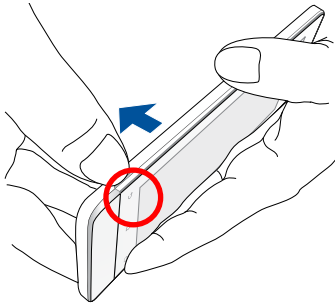

3. Orient the micro-SIM card with its gold-plated contacts facing downward then insert it into the Micro-SIM card 1 slot.
4. Push the micro-SIM card all the way into the slot until it is seated firmly in place.

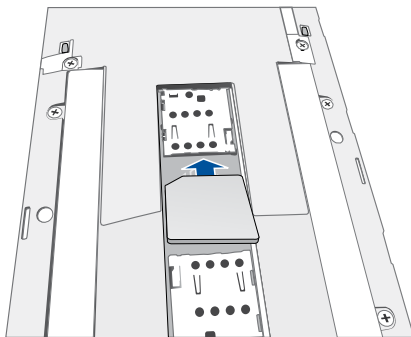



5. If you wish to install another micro-SIM card, orient the micro-SIM card with its gold-plated contacts facing downward then insert it into the Micro-SIM card 2 slot.
6. Put the rear cover back in place. Press down the rear cover on all sides to secure in place.

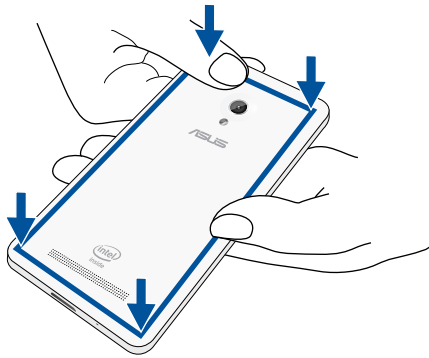

---

**NOTE:** If you installed two micro-SIM cards, go to **Settings > Dual SIM card settings** for information and configuration of your SIM cards.

---

## Removing a Micro-SIM card

---

**CAUTION:** Be extra careful when handling a micro-SIM card. ASUS is not responsible for any loss or damage incurred to your micro-SIM card.

---

To remove a micro-SIM card:

1. Turn off your device.
  2. Pry the cover loose from the groove on the bottom-left corner, then pull the rear cover off.
- 

**CAUTION!** Be careful when you pry open the cover.

---

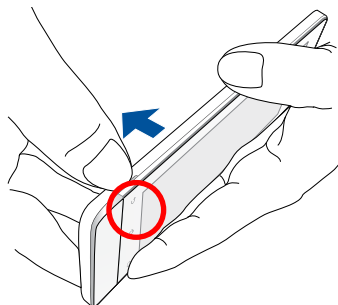

3. Press the micro-SIM card that you want to remove, then pull it out.

Repeat the same step, if you wish to remove the other micro-SIM card.

4. Put the rear cover back in place. Press down the rear cover on all sides to secure in place.

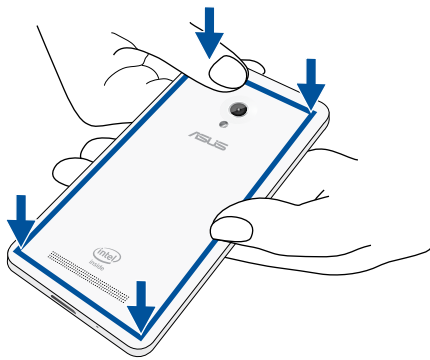

## Installing a memory card

Your ZenFone supports a microSD™, microSDHC™, and microSDXC™ memory card with up to 64 GB capacity.

---

**NOTE:** Some memory cards may not be compatible with your ZenFone. Ensure that you use only compatible memory cards to prevent loss of data, damage to your device or memory card, or both.

---

### CAUTION!

- Be extra careful when handling a memory card. ASUS is not responsible for any data loss or damage incurred to your memory card.
  - Do not insert a micro-SIM card into the memory card slot! If a micro-SIM card happens to be inserted into the memory card slot, bring your device to an ASUS-qualified service personnel.
- 

To install a memory card:

1. Turn off your device.
2. Pry the cover loose from the groove on the bottom-left corner, then pull the rear cover off.

---

**CAUTION!** Be careful when you pry open the cover.

---

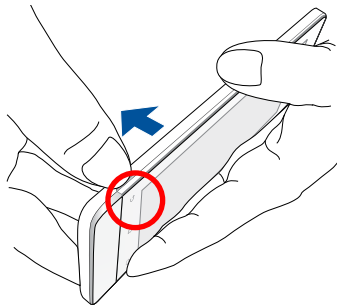

2. Align and insert a memory card into the memory card slot.
3. Push the memory card all the way into the slot until it is seated firmly in place.

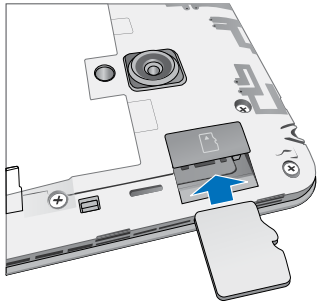

4. Put the rear cover back in place. Press down the rear cover on all sides to secure in place.

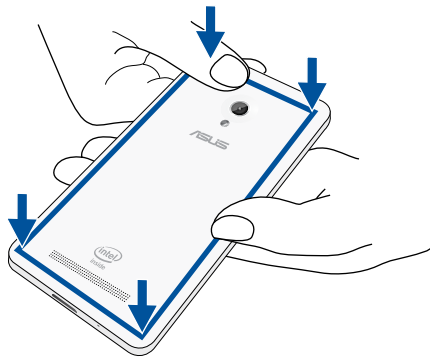

---

**NOTE:** After installing a formatted memory card, you can access its contents from **File Manager > sdcard**.

---

## Removing memory card

---

### CAUTION!

- Be extra careful when handling a memory card. ASUS is not responsible for any data loss or damage incurred to your memory card.
  - Eject the memory card properly to safely remove it from device. To eject the memory card, go to **Home > All Apps > Settings > Storage > Unmount external storage**.
- 

To remove a memory card:

1. Turn off your device.
  2. Pry the cover loose from the groove on the bottom-left corner, then pull the rear cover off.
- 

**CAUTION!** Be careful when you pry open the cover.

---

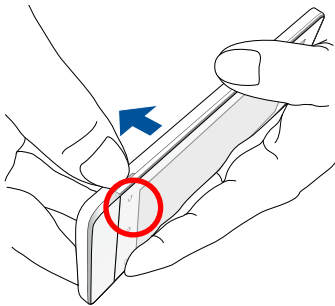

2. Press the memory card to eject, then pull it out.

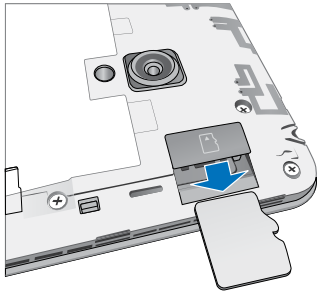

3. Put the rear cover back in place. Press down the rear cover on all sides to secure in place.

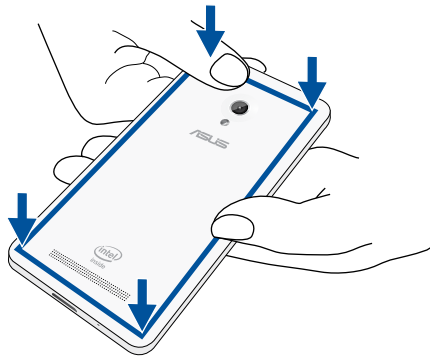

## Charging your ZenFone

Your ZenFone comes partially charged but you must charge it fully before using it for the first time. Read the following important notices and cautions before charging your device.

---

### **IMPORTANT:**

- Use only the bundled AC power adapter and micro-USB cable to charge your ZenFone. Using a different AC power adapter and cable may damage your device.
  - Peel off the protective film on the AC power adapter and micro-USB cable before using it with your device.
  - Ensure to plug the AC power adapter to a compatible power outlet. You can plug the AC power adapter to any compatible 100~240 V outlet.
  - The output voltage of the AC power adapter for this device is DC 5.2V, 1.35A.
  - When using your ZenFone while plugged-in to a power outlet, the power outlet must be near your device and easily accessible.
  - To conserve electricity, unplug the AC power adapter from the power outlet when not in use.
  - Do not place heavy objects on top of your ZenFone.
- 

### **CAUTION!**

- While charging, your ZenFone can become warm. This is normal, however, if your device becomes unusually hot, disconnect the micro-USB cable from your device and send the device, including the AC power adapter and cable to an ASUS-qualified service personnel.
  - To prevent any damage to your ZenFone, AC adapter, or micro-USB cable. Ensure that the micro-USB cable, AC adapter, and your device are connected properly before charging.
-



To charge your ZenFone:

1. Connect the micro USB cable to the AC power adapter.
2. Plug the AC power adapter to a grounded power outlet.
3. Connect the micro USB cable to your ZenFone.

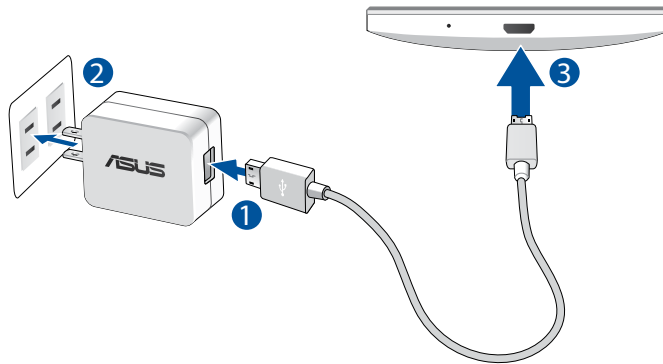

---

**IMPORTANT:**

- Charge your ZenFone for eight (8) hours before using it in battery mode for the first time.
- The status of battery charge is indicated by the following icons:

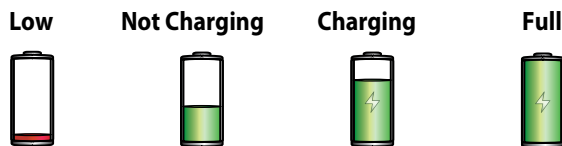

4. When fully-charged, disconnect the USB cable from your ZenFone first before unplugging the AC power adapter from the power outlet.
- 

**NOTES:**

- You can use your device while charging but it may take longer to fully charge the device.
  - Charging your device via USB port of a computer may take longer to fully charge the device.
  - If your computer does not provide enough power for charging via USB port, charge your ZenFone using the AC power adapter plugged to a power outlet instead.
-

## Turning your ZenFone on or off

### Turning your device on

To turn your device on, press and hold the power button until your device vibrates and starts up.

### Turning your device off

To turn your device off:

1. If your screen is turned off, press the power button to turn it on. If your screen is locked, unlock the device screen.
2. Press and hold the power button, then when prompted, tap **Power off** then tap **OK**.

### Sleep mode

To put your device in sleep mode, press the power button once until the screen turns off.

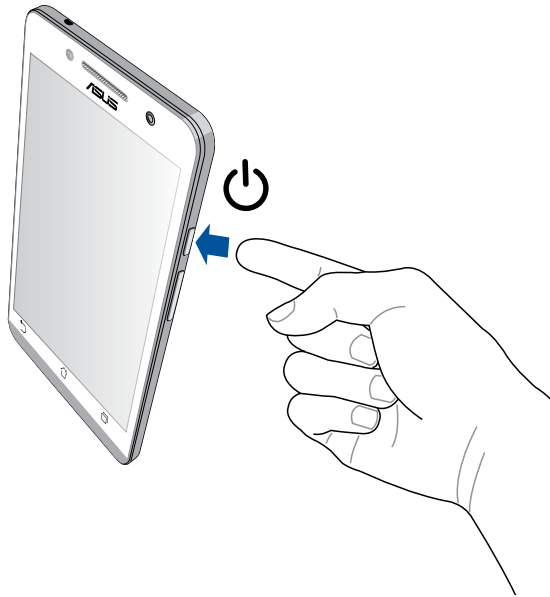

## First time use

When you turn your Zen device on for the first time, Setup Wizard will guide you through the setup process. Follow the on-screen instructions to select your language, select input methods, setup your mobile network and Wi-Fi, sync accounts, and configure your location services.

Use your Google or ASUS account to setup your device, if you do not have a Google or ASUS account yet, go ahead and create one.

## Google Account

Using a Google Account allows you to fully utilize these Android OS features:

- Organize and see all your information from anywhere.
- Automatically backup all your data.
- Leverage Google services conveniently from anywhere.

## ASUS Account

Having an ASUS Account gets you to enjoy the following perks:

- Personalized ASUS support service and warranty extension for registered products.
- Free 5 GB of Cloud storage space.
- Receive the latest device and firmware updates.

---

**NOTE:** You can also use the Setup Wizard to reconfigure your device, any time at your convenience. From the **Home Screen** go to **All Apps > Setup Wizard**.

---

## **Battery power conservation tips**

The battery charge is the lifeline of your Zen device. Here are some battery power conservation tips that helps preserve the power of your Zen device battery.

- When not in use, press the power button to put the device in sleep mode.
- Activate Smart Saving in Power Saver app.
- Set audio to Power Saving mode.
- Decrease brightness of display.
- Keep the speaker volume to a low level.
- Disable Wi-Fi feature.
- Disable Bluetooth feature.
- Disable Miracast feature.
- Disable GPS.
- Disable the screen auto-rotate feature.
- Disable all auto-sync features in your device.



# 2



*There's no place like Home*

2

*There's no place like Home*

# Zen Home features

## Home screen

Get reminders of important events, app and system updates, weather forecasts, and text messages from people who really matter to you, right from your Home screen.

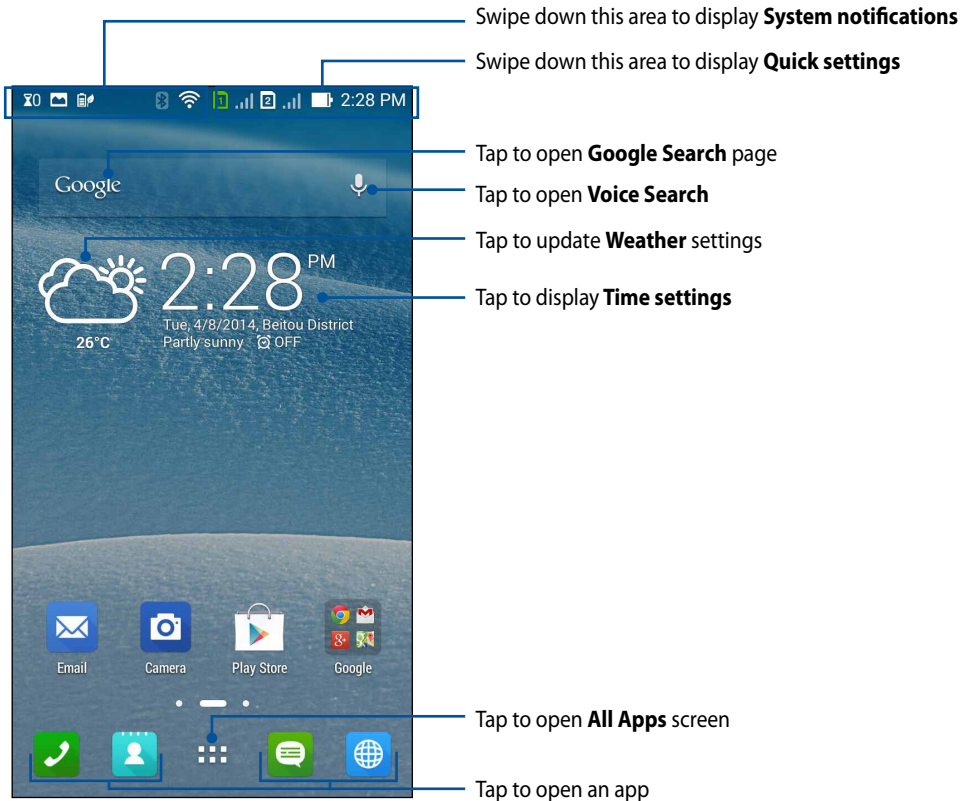

Swipe the Home screen to the left or right to display the extended Home screen



## Understanding icons

These icons are shown on the status bar and will guide you of the current status of your ZenFone.



This icon shows the signal strength of your mobile network.



This icon shows that a micro SIM card is inserted in micro SIM card slot 1.



This icon shows that a micro SIM card is inserted in micro SIM card slot 2.

**NOTE:** If the SIM card icon is displayed in green, it indicates that it is set as the default network.



This icon shows that you have an unread message.



This icon shows the signal strength of your Wi-Fi connection.



This icon shows the battery status of your ZenFone.



This icon shows that a microSD card is inserted in your ZenFone.



This icon shows that you took screenshots of your ZenFone.



This icon shows that your ZenFone is on Airplane mode.



This icon shows that Wi-Fi hotspot of your ZenFone is enabled.



This icon shows that Smart Saving mode is enabled.



This icon shows that Mute mode is enabled.



This icon shows that Vibrate mode is enabled.



This icon shows the download status of an app or file.



This icon shows that Reading mode is enabled.

## Managing your home

Stamp your own personality to your Home screen. Select an attractive design as your wallpaper, add shortcuts for quick access to your fave apps, and add widgets for a quick review of important info. You can also add more pages so you can add and quickly access or review more apps or widgets on your Home screen.

- To add items to home, tap and hold an empty area on your Home screen and select any of these categories: **Apps**, **Widgets**, **Wallpaper**, and **Edit page**.
- To go through the pages of your Home screen, swipe left or right.

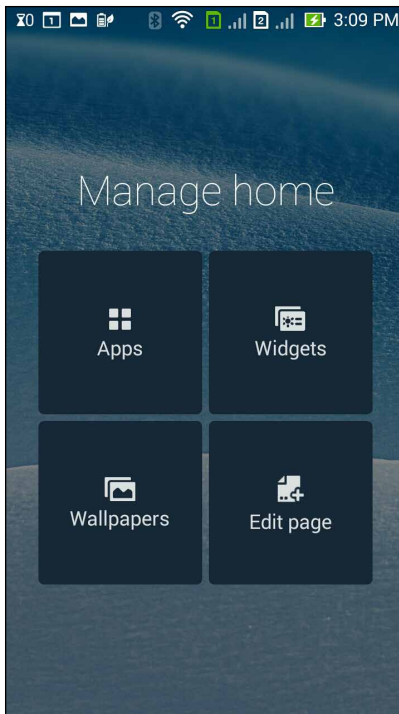

## App shortcuts

Add shortcuts to quickly access your often-used apps right from your Home screen.

To add an app shortcut:

1. Tap and hold an empty area on your Home screen and select **Apps**.
2. From **All Apps**, tap and hold an app, then drag it to an empty area on your **Home screen**.

To remove an app shortcut:

From your **Home screen**, tap and hold an app, then drag it to **X Remove** on the top of your screen.

## Widgets

Add widgets for a quick review of your calendar, maps, battery status, and more.

To add a widget:

1. Tap and hold an empty area on your Home screen and select **Widgets**.
2. From **Widgets**, tap and hold a widget, then drag it to an empty area on your Home screen.

To remove an app shortcut:

From your **Home screen**, tap and hold a widget, then drag it to **X Remove** on the top of your screen.

---

**NOTE:** You can also tap  on your Home screen to view **All Apps** and **Widgets**.

---

## Wallpapers

Let your apps, icons, and other Zen elements sit on an attractively designed wallpaper. You may add a translucent background tint to your wallpaper for readability and clarity. You can also select an animated wallpaper to make your screen come alive.

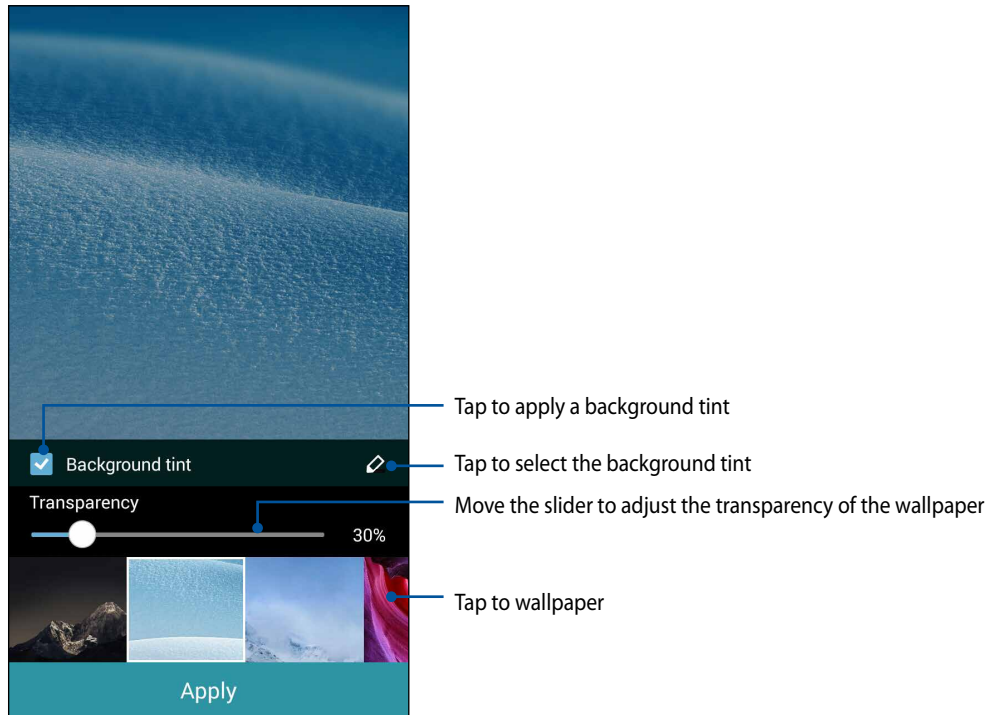



## Applying wallpaper and background tint

To apply wallpaper and background tint:

1. Tap and hold an empty area on your Home screen and select **Wallpapers**.
2. Select where you want your wallpaper: on your **Home screen**, **Lock screen**, or **Home screen and Lock screen**. If you do not want to add a background tint to your wallpaper, skip to step 5.
3. Tick **Background tint**, then adjust the transparency level.
4. Tap  then select a color.
5. Select a wallpaper, then tap **Apply**.

---

### NOTES:

- A background tint can be applied to your **Home screen**, or **Home screen and Lock screen**.
- You can also set up your wallpaper settings from    > **Settings** > **Display**.



---

## Applying an animated wallpaper

To apply an animated wallpaper:

1. Tap and hold an empty area on your Home screen and select **Wallpapers**.
2. Select where you want your wallpaper: on your **Home screen**, or **Home Screen and Lock screen**.
3. Select an animated wallpaper, then tap **Apply**.

---

**NOTE:** You can also set up your wallpaper settings from    > **Settings** > **Display**.

---

## Quick settings

Enable functions with just one tap and personalize your ZenFone using **Quick settings**. This unique Zen feature also shows system notifications that help you track recent updates and changes on your ZenFone.

You can launch Quick settings anytime you need it, even if you are currently using an app on your ZenFone.

### Launching Quick settings

Swipe down from the upper right corner of your ZenFone's screen.

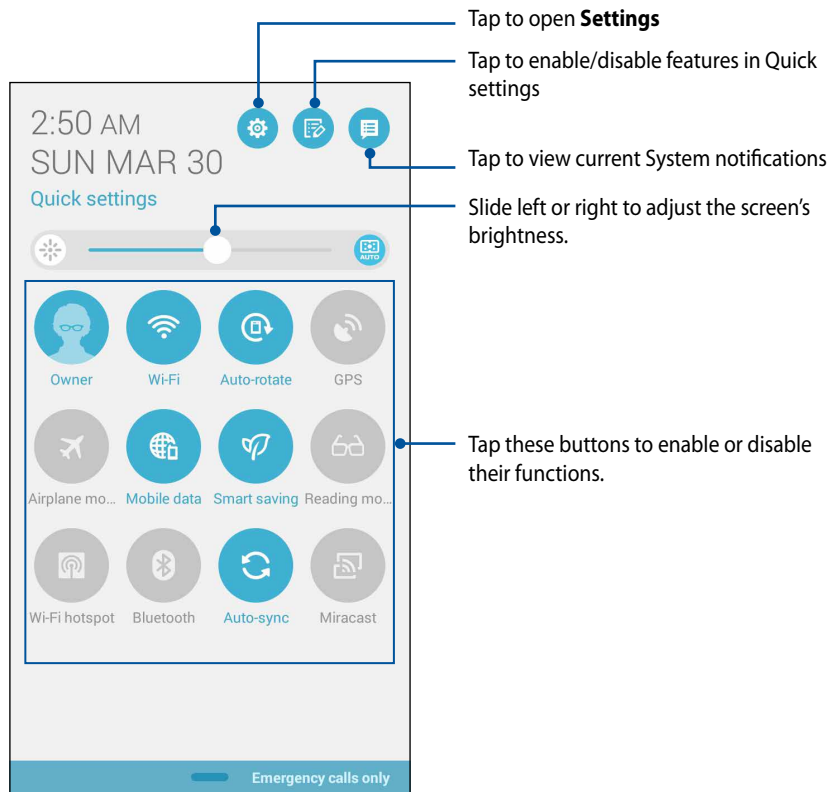

## Inside Quick settings

Use Quick settings as a one-tap access for some of the features and programs of your ZenFone.

### Access settings

Tap  to launch your ZenFone's Settings app.

### View ASUS Quick settings list

Tap  to view the current list of features that you can enable or disable from the Quick settings notification panel.

### View system notifications

Tap  to view the current updates and changes made on your ZenFone.

### Go back to the Quick settings home screen

From the System notifications screen, tap  to go back to the home screen.

### Access Display settings

Tap  to launch the Display app.

### Toggle auto-brightness

Tap  to enable or disable the auto-brightness feature for your ZenFone's display.

## Using the Quick settings Notification Panel

The Quick settings Notification Panel provides a one-tap access to some of the wireless features and settings of your ZenFone. Each of these features are represented by a button.

---

**NOTE:** A blue button indicates that the feature is currently enabled while a gray button indicates a disabled feature.

---

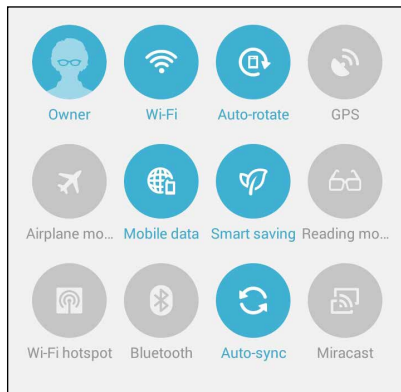

## Adding or removing buttons

To add or remove existing buttons from the ASUS Quick Settings notification panel:

1. Launch Quick settings then tap .
2. Tap the box beside the feature to add or remove it from the ASUS Quick Setting Notification Panel.

---

**NOTE:** A checked box indicates that the feature's button is accessible via the ASUS Quick Settings Notification Panel while an unchecked box means the opposite.

---

3. Tap  to go back and view the current ASUS Quick Settings notification panel



## Using System notifications

Inside System notifications, you can see the latest updates done and system changes made on your ZenFone. Most of these changes are data and system-related. The System notifications screen is intuitive and can be navigated through the following ways:

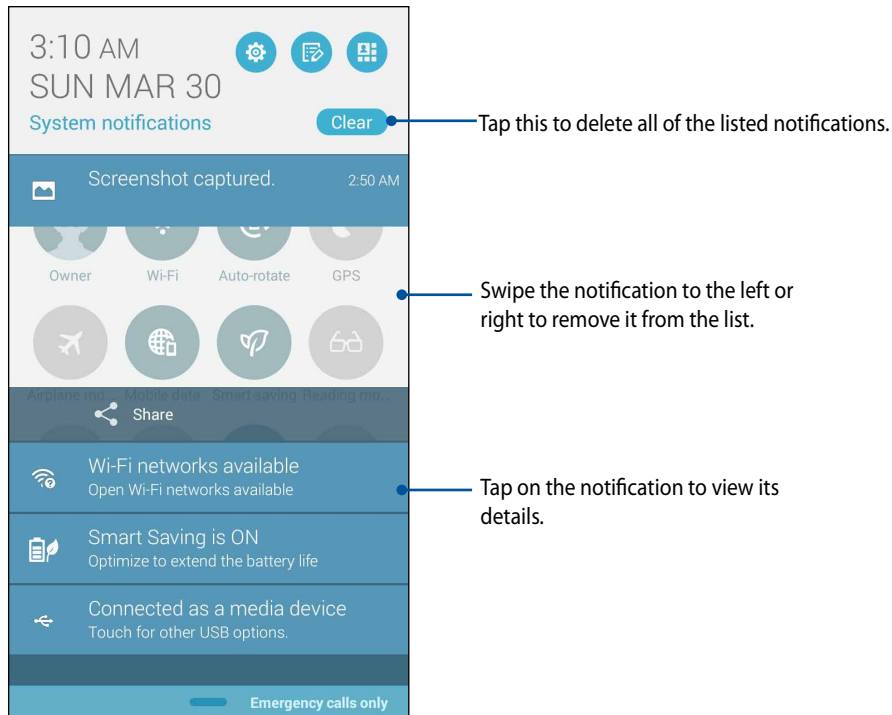



## ASUS keyboard settings

Create SMS messages, emails, and log-in passwords using your ZenFone's touch keyboard.

To access the ASUS keyboard settings:

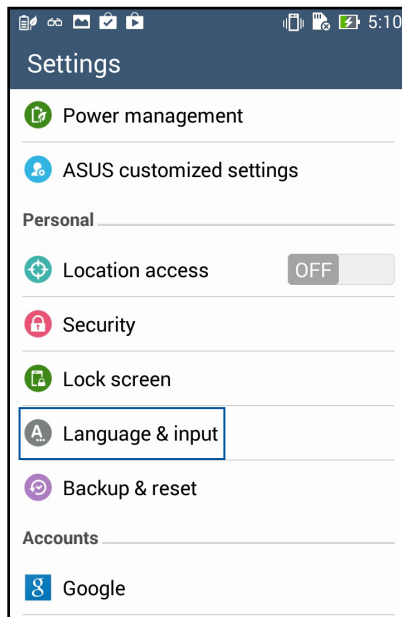
1. Launch Quick settings then tap .
2. Scroll down the **Settings** screen and select **Language & input**.



3. Tap  beside **ASUS keyboard settings**.
4. Configure the settings according to your personal preferences.

## Voice Search

Make voice commands to your ZenFone then watch it listen and take action using the Voice Search app. Using Voice Search, you can make voice commands to accomplish the following:

- Search for data and information online or on your ZenFone
- Launch apps inside your ZenFone
- Get directions going to a location

---

**IMPORTANT!** Your ZenFone must be connected to the Internet to be able to use this feature.

---

## Launching Voice Search

1. Tap  > **Voice Search**.
2. Once the mic icon turns red, start saying your voice command.

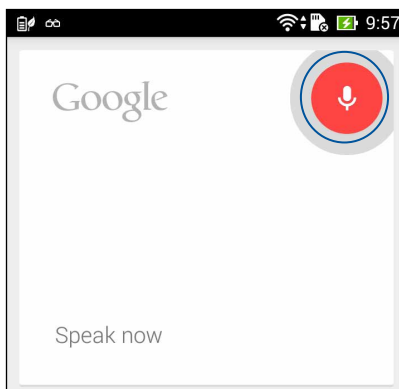



---

**NOTE:** Speak clearly and use concise phrases when talking to your ZenFone. It also helps to start your commands with a verb related to the ZenFone feature you want to use.

---

## Customizing voice search results from the Phone search group

If you want to set parameters for the voice search results gathered from your Google account and your ZenFone's data, you may do so using the following steps:

1. On your ZenFone's home screen, tap  > **Voice Search**.
2. Tap  > **Settings**.

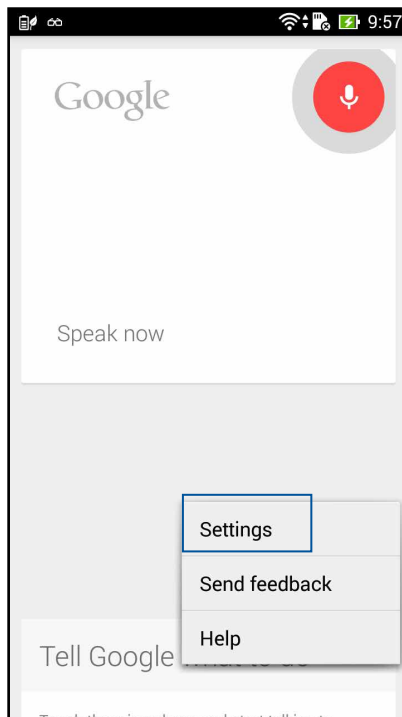

3. Tap **Phone search**.

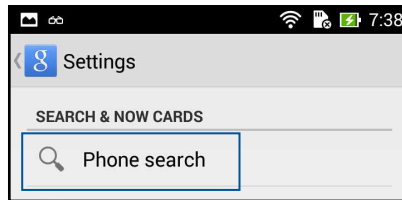

4. Tick the box of the search groups you would like to include as source when using **Voice Search**.

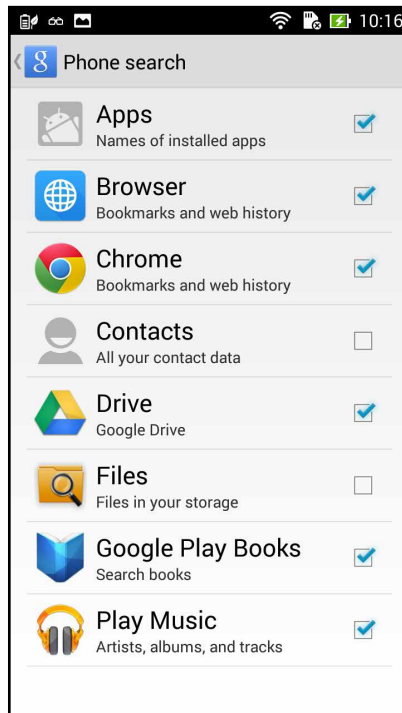

## Lock Screen

By default, the lock screen appears after turning on your device and while waking it up from sleep mode. From the lock screen, you can proceed to your device's Android® system by swiping on your touch screen panel.

Your device's lock screen can also be customized to regulate access to your mobile data and apps.

### Customizing your lock screen

If you want to change your lock screen settings from the default **Swipe** option, refer to the following steps:

1. Launch Quick settings then tap .
2. Scroll down the **Settings** screen and select **Lock screen**.

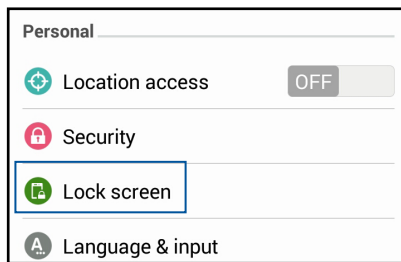

3. In the next screen, tap **Screen lock**.

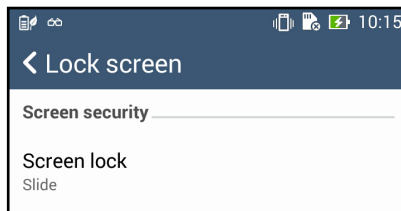

4. Tap the screen lock option you would like to use.

## Connecting your ZenFone to your computer

Connect your ZenFone to your computer's USB port to charge it or transfer files between devices.

---

### NOTES:

- Charging through a USB port of a computer may take longer time to complete.
  - If your computer does not provide enough power for charging the ZenFone, charge your ZenFone via the grounded power outlet instead.
- 

## Connecting with your notebook

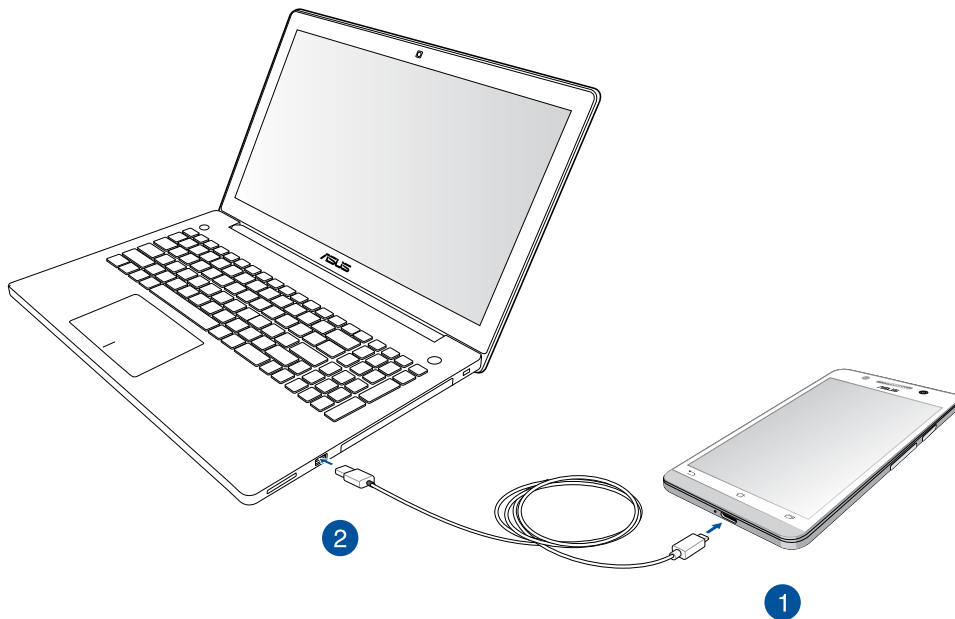

## Connecting with your desktop PC

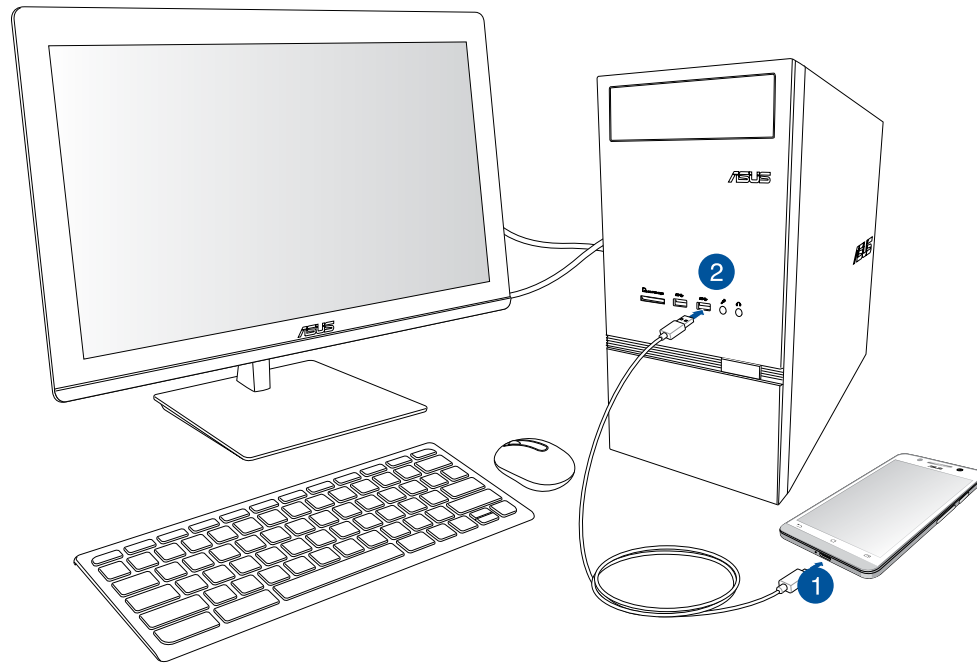

To connect your ZenFone to your computer:

1. Plug the micro USB connector into your ZenFone.
2. Plug the USB connector to the USB port of your computer.



3



*Call in style*

3

*Call in style*

## Managing contacts

Add, import, or export your contacts from your SIM or email accounts to your ZenFone and vice-versa.

### Adding contacts

To add contacts:

1. Tap **Contacts** app then tap **Create a new contact**.
2. On the Contacts screen, select the account that you want to save your contact:
  - a. Device
  - b. SIM card storage (SIM1 or SIM2)
  - c. E-mail account

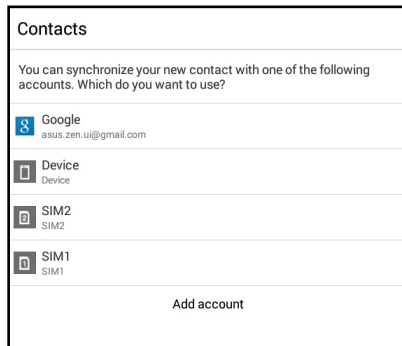

---

**NOTE:** If you don't have an e-mail account, tap **Add account** then create one.

---

3. Follow the succeeding onscreen instructions to add and save the new contact.

## Importing contacts

Import your contacts and their respective data from one contact source to your ZenFone, e-mail account, or a micro SIM card.

To import contacts:

1. Tap **Contacts** app then tap  > **Manage contacts**.
2. Tap **Import/export** then select from the following importing options:
  - a. Import from SIM 1 card/Import from SIM 2 card
  - b. Import from storage
3. Select from the following accounts to save the contact:
  - a. Email account/s
  - b. Device
  - c. SIM1/SIM2
4. Tick to select the contacts that you wish to import and when done, tap **Import**.

## Exporting contacts

Export your contacts to any of the storage accounts in your ZenFone.

1. Tap **Contacts app** then tap  > **Manage contacts**.
2. Tap **Import/export** then select from the following exporting options:
  - a. Export to SIM 1 card/Export to SIM 2 card
  - b. Export to storage
3. Tap to select the contacts from the following accounts:
  - a. All contacts
  - b. E-mail account/s
  - c. Device
  - d. SIM1/SIM2
4. Tick the contacts that you want to export.
5. When done, tap **Export**.

# Making and receiving calls

## Make a call

Your ZenFone offers you many ways to make a call. Call your friends from saved contacts list, dial a phone number directly, or even dial a number without keying in a passcode on the lock screen.

### Calling from Contacts app

Use the Contacts app to make a call from your contacts list.

To call via the Contacts app:

1. From your Home screen, tap **Contacts** app then look for the contact name that you wish to call.

---

**NOTE:** To view all contacts from all contact accounts, tap **Contacts to display** dropdown list then tick all accounts.

---

2. Tap the contact name then tap the number.

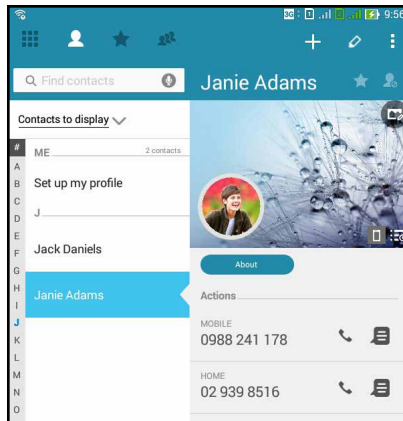

3. If there are two SIM cards installed, tap the SIM card that you want to make the call.

## Dialing a phone number

Use the Phone app to directly dial a phone number.

To call via the Phone app:

1. From your Home screen, tap **Phone** app then tap the number keys.
2. Select from call buttons **SIM1** or **SIM2** to dial the number.

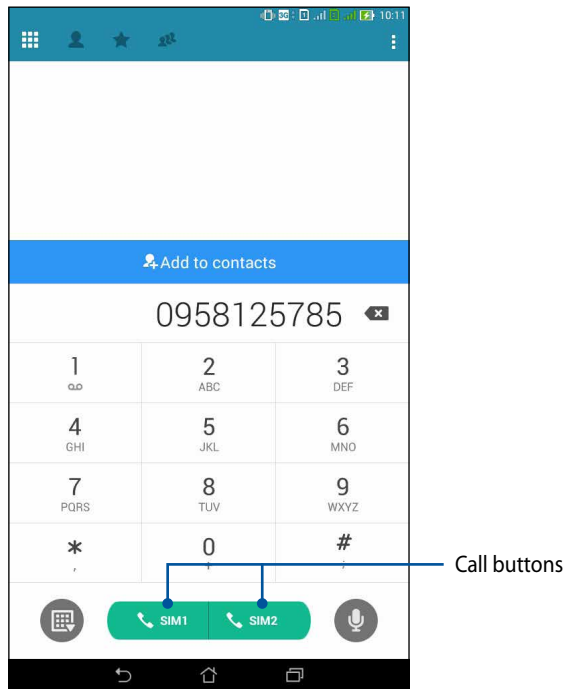

---

**NOTE:** The labels of the call buttons may vary depending on the setting that you made to your micro SIM cards. Refer to section **Dual SIM feature** of this user manual for more information.



---

## Receive a call

The touch screen of your ZenFone lights up when there is an incoming call. The display of the incoming call also varies, depending on the status of your ZenFone.

## Answering a call

There are two ways to answer a call depending on the status of your ZenFone:

- If your device is active, tap **Answer**. To reject a call, tap **Decline**.
- If your device is locked, drag  to  to answer or to  to reject the call.

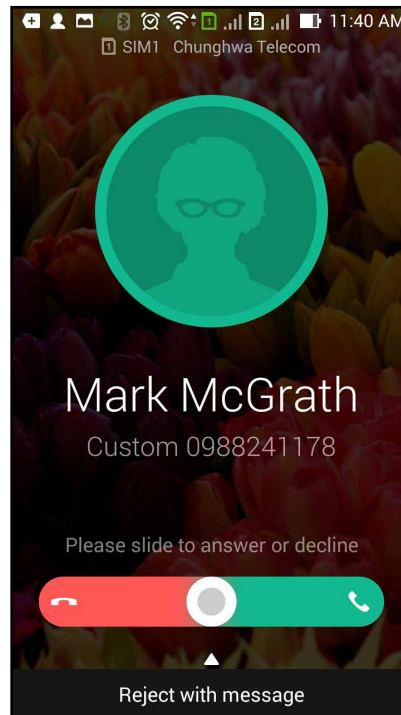
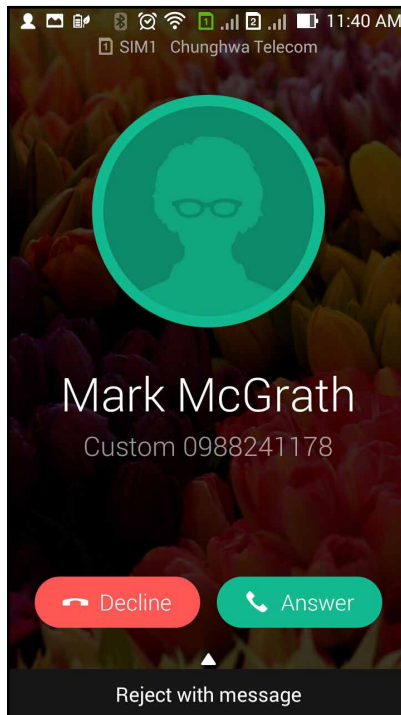

**NOTE:** You can also send a message to reject the call. Swipe up **Reject with message** then select from the displayed options to send the message.

## Dual SIM feature

The dual SIM feature of your ZenFone lets you manage the settings of the installed micro SIM cards. With this feature, you can enable/disable the micro SIM cards, assign SIM names, or set one as a preferred network.

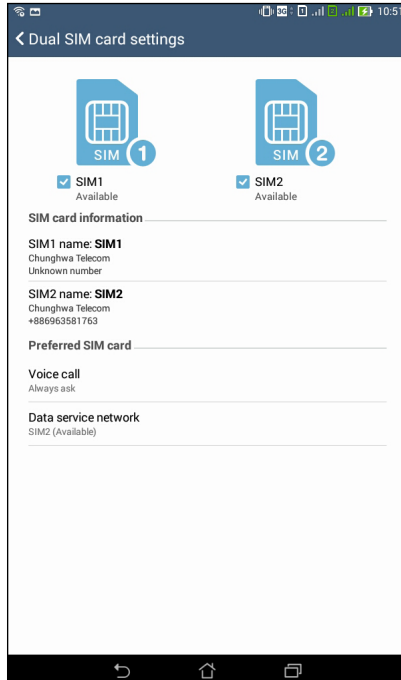

## Renaming your micro SIM cards

Change the names of your micro SIM cards on your ZenFone so that you can identify them easily.

To change the names of your micro SIM cards, tap **SIM1 name: SIM1** or **SIM2 name: SIM2** then key in the names for your micro SIM cards.

---

**NOTE:** If your SIMs have different mobile service providers, we recommend you to use the names of these providers for your SIM names. If both SIMs have the same mobile service provider, we recommend you to use the mobile numbers for your SIM names.

---



## Assigning a default micro SIM card

Assign a micro SIM card as your preferred SIM for voice calls and data services.

### SIM card for voice calls

When you make a call, your ZenFone automatically uses the preferred micro SIM card to connect the call.

To assign a micro SIM card for voice calls, tap **Voice call** then tap the SIM that you want to use.

Voice call	
SIM1 (Available)	<input checked="" type="radio"/>
SIM2 (Available)	<input type="radio"/>
Always ask	<input type="radio"/>
Cancel	

---

**IMPORTANT!** You can only use this feature if you make a call from your contacts list.

---

### SIM card for data service

To assign a micro SIM card for data service, tap **Data service network** then select from **SIM1** or **SIM2**.



Data service network	
SIM1 (Available)	<input checked="" type="radio"/>
SIM2 (Available)	<input type="radio"/>
Cancel	

## Backup/restore call logs

Have your call logs stored in your ZenFone to track the calls that you've received, made, or missed. You can also send the saved call logs to your online storage account or e-mail it via the installed e-mail apps in your ZenFone.



### Creating a call log backup

To back up call logs:

1. From the Home screen, tap **Phone** then tap  to hide the keypad.
2. Tap  then tap **Backup call log**.
3. Tap **Backup call log to device** to save the call log backup in your ZenFone. To email the call log backup, tap **Backup call log to device and send out**.
4. Key in a backup file name then tap **OK**. After the backup is successful, tap **OK**.

### Restoring call log backups

To restore call log backups:

1. From the Home screen, tap **Phone** then tap  to hide the keypad.
2. Tap  then tap **Restore call log**.
3. Select a call log backup that you want to restore, then tap **OK**.
4. After restoring call log is successful, tap **OK**.
5. Tap  to view the restored call logs.

4



*Send messages and more*

4

*Send messages and more*

## Messaging

Messaging lets you send, promptly reply, or reply at a later time to important messages from your contacts in any of your SIM cards installed on your device. You can also email your message threads or conversations to others to keep them in the loop.

### Sending or replying to messages



To start a message thread:

1. From the **Home screen**, tap , then tap **+**.
2. In the **To** field, enter the number or tap **+** to select a contact from your list.
3. Start composing your message in the **Type message** field.
4. When you're done, select the SIM account where you're going to send your message from.

## Setting up your messaging options

You can forward a message thread or conversation to others, and set an alert so you can reply to an important message at a convenient time.

To forward an SMS conversation:

1. From the **Home screen**, tap .
2. Tap to select a sender image, then tap  > **Forward SMS conversation**.
3. Tap **Select All** or any of the messages from the thread, then tap **Forward**.
4. In the **To** field, tap  to select a contact's email address or mobile number.
5. When you're done, select the SIM account where you're going to send your message from. The conversation will be forwarded as an MMS (Multimedia Messaging Service) message.

---

### NOTES:

- Ensure that you have MMS subscription with your mobile service provider.
  - Ensure that data access is enabled on your device. From your Home screen, tap  > **Settings** > **More...** > **Mobile networks**, then tick **Data enabled**.
  - Mobile data and messaging rates apply when forwarding conversations to others.
- 

To set a message as a reply-later task:

When you receive an important message at an untimely time, you can add it to your to-do list so you can reply to it at a later time.

1. In the message screen, tap .
2. Tap **Reply later**. The message is added to your **Do It Later** tasks.
3. When you're ready to reply to the message, go to the **Do It Later** app from **All Apps**.

## Omlet Chat

Omlet Chat is an online messaging app that lets you chat with your friends on the spot, send multimedia messages, and store your data on any of your Cloud accounts securely and privately.

---

**NOTE:** Omlet Chat app may only be available in some countries.

---

### Registering to Omlet Chat

There are two ways to register to Omlet Chat, via mobile phone number and e-mail account or Facebook account.

#### Registering your mobile phone number

Use your mobile phone number to sign in to Omlet Chat.

To register your mobile phone number:

1. Tap  then tap **Omlet Chat** app.
2. On the Sign in page, select your country and key in your mobile phone number then tap **Next**. Omlet Chat app sends a text message containing the PIN to proceed with the registration.
3. Key in the PIN then tap **Next**.
4. Key in your name then tap **Get Started**.
5. If you want Omlet Chat to automatically update your friends from your contacts list, tap **Okay! Let's do it!** If you want to add your friends manually, tap **No thanks**.

---

#### NOTES:

- A series of screens appear for the app's introduction. Follow the onscreen instructions until Omlet Chat main screen appears.
  - Omlet Chat app can only add contacts with Omlet chat installed to their devices.
- 

6. On the Omlet Chat main screen, tap **START CHAT** then select a contact that you want to chat.

## Registering your e-mail or Facebook account

Use your e-mail or Facebook account to sign in to Omlet Chat.

To register your e-mail or Facebook account:

1. Tap  then tap **Omlet Chat** app.
2. On the Sign in page, tap **Connect a different account here** to select an account from **Email** or **Facebook**, then follow the succeeding onscreen instructions.
  - If you select Email, key in your e-mail account then tap **Next**. Omlet Chat app will send a confirmation message to your e-mail account.
  - If you select Facebook, Omlet Chat app will take you to Facebook to log in to your Facebook account.
3. Key in your name then tap **Get Started**.
4. If you want Omlet Chat to automatically update your friends from your contacts list, tap **Okay! Let's do it!** If you want to add your friends manually, tap **No thanks**.

---

### NOTES:

- A series of screens appear for the app's introduction. Follow the onscreen instructions until Omlet Chat main screen appears.
  - Omlet Chat app can only add contacts with Omlet Chat installed to their devices.
- 

5. On the Omlet Chat main screen, tap **START CHAT** then select a contact that you want to chat.

## Sending Omlet invites

To add contacts to Omlet Chat, you need to send an invite to your friends to download and use Omlet Chat.

To send Omlet invitation:

1. Tap **Contacts** on the Omlet Chat menu.
2. From the Add contacts screen, tap **Invite a friend** then select from following options:
  - **Invite an Email or Phone number.** Key in the mobile phone number or e-mail of your friend then tap **Go**.
  - **Invite Facebook friends.** Tap to log in to your Facebook account.
  - **Invite address book friends.** Tap to invite friends from the contacts list of your e-mail.
3. Omlet Chat app gathers the contacts of your account. After selecting the contacts, follow the onscreen instructions to complete the operation.
  - For Facebook app, tick to select the contacts, then tap **Send**.
  - For address book, tick to select the contacts, then tap **SEND INVITES**.



## Using Omlet chat

Send text and multimedia messages for a fun, creative, and interactive conversation.

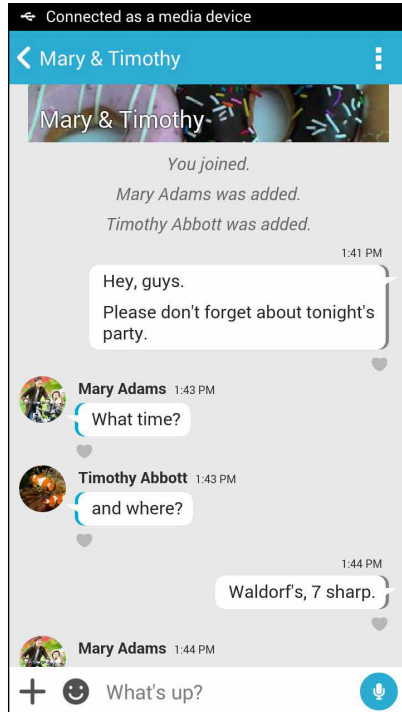

To start conversation, tap **Contacts** from the Omlet Chat menu then tap the contact name.



### Sending a chat message

To send a chat message, key in your message in **What's up** field then tap .

### Sending a voice message

To send a voice message, tap and hold  while saying your message then release  to send.

## Sending a virtual sticker

To send a virtual sticker, tap 😊 then select from the available virtual stickers.

**NOTE:** You can download more virtual stickers from Sticker Store. To download the virtual stickers, tap 😊 > + then tap ↓.

## Sending multimedia messages

From the chat thread, tap + then select from these icons to send a specific multimedia message.

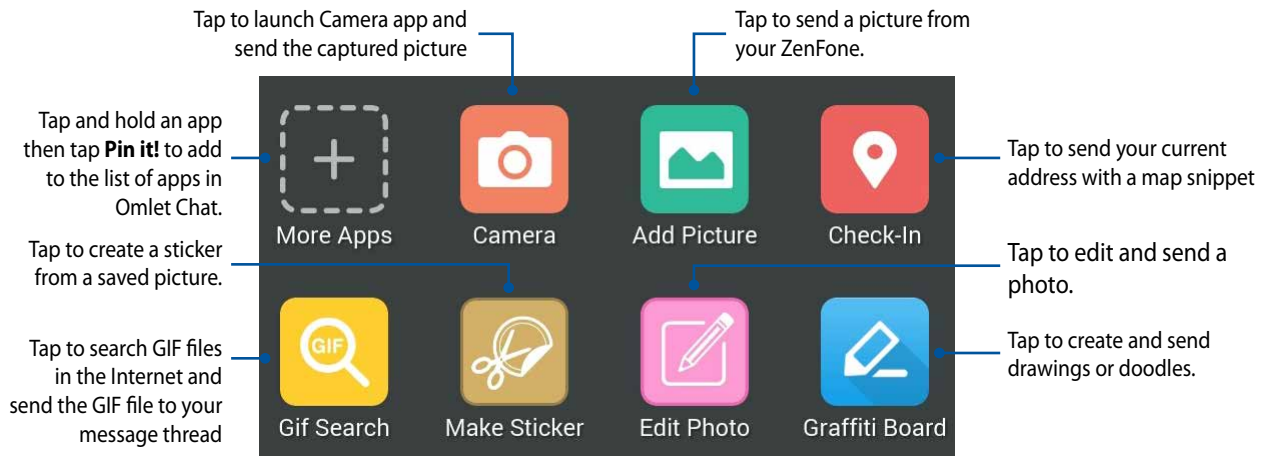

Swipe up the screen shown above to view these icons:

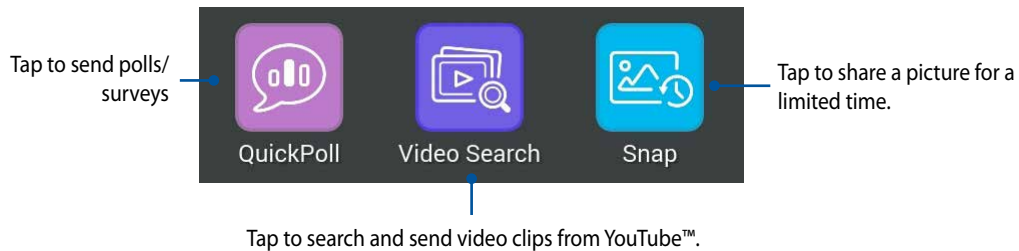

5



*Access your emails*

5

*Access your emails*

## Email

Add Exchange, Gmail, Yahoo! Mail, Outlook.com, POP3/IMAP accounts so you can receive, create, and browse emails right from your device. You can also sync your email contacts from these accounts to your ZenFone.

---

**IMPORTANT!** You must be connected to the Internet so you can add an email account or send and receive emails from added accounts.

---

### Setting up an email account

To set up an email account:

1. From the Home screen, tap **Email** to launch the Email app.
2. Tap the mail provider you want to setup.
3. Key in your email address and password and tap **Next**.

---

**NOTE:** Wait while your device automatically checks your incoming and outgoing mail server settings.

---

4. Configure the **Account settings** such as inbox checking frequency, sync days, or notification for incoming emails. When done, tap **Next**.
5. Key in an account name that you want to be displayed in the outgoing messages, then tap **Next** to log into your inbox.

## Adding email accounts

To add other email accounts:

1. From the Home screen, tap **Email** to launch the Email app.
2. Tap  > **Settings**, then add an email account.
3. Tap the mail provider you want to setup.
4. Follow the succeeding instructions to complete setting up your new email account.

---

**NOTE:** You may also refer to steps 3 to 5 in the **Setting up an email account** section of this manual to complete this setup process.

---

## Gmail

Using the Gmail app, you can create a new Gmail account or synchronize your existing Gmail account so you can send, receive, and browse emails right from your device.

### Setting up a Gmail account

1. Tap **Google** then tap **Gmail**.
2. Tap **Existing** and key in your existing Gmail account and password, then tap .

---

#### NOTES:

- Tap **New** if you do not own a Google account.
  - When signing in, you have to wait while your device communicates with Google servers to setup your account.
-

3. Use your Google account to backup and restore your settings and data. Tap [right arrow icon] to sign in to your Gmail account.

---

**IMPORTANT!** If you have several email accounts aside from Gmail, use Email app to set up and access all your email accounts.

---







# 6



*Capture moments*

## Launching the Camera app

Capture images and record videos using your ZenFone's Camera app. Refer to any of the steps below to open the Camera app.

### From the lock screen

Drag down  until the camera app is launched.

### Using the camera widget

From the lock screen, swipe to the left to launch the Camera widget that automatically opens the Camera app.

### From the home screen

Tap **Camera**.

### Using the volume key

While your ZenFone is on sleep mode, double-click the volume key to wake it up and immediately launch the Camera app.

---

**NOTE:** Before using the volume key to launch the Camera app, enable this function from **Settings > Lock screen**, then slide **Instant camera** to **ON**.

---

## Using Camera for the first time

After launching the Camera for the first time, two consecutive features appear to help you get started: Tutorial and Image locations.

### Tutorial

If it is your first time to use your ZenFone's camera, you will encounter the following tutorial screen after launching the **Camera** app. Refer to the following steps to proceed from this screen.

1. On the Tutorial screen, tap **Skip** if you want to skip viewing or **Start** to view the basic tutorial about using Camera.
2. After tapping either of these options, you will then proceed to the Image Locations screen.

## Image Locations

After going through the Tutorial screen, the Image Locations screen appears to help you create automatic location tags for your images and videos. Refer to the following steps to proceed from this screen:

1. On the Image Locations screen, tap **No thanks** to proceed to the camera screen or **Yes** to set up location tagging for your captured images and videos.
2. Slide **Location Access** to **ON** to enable the location tagging feature.
3. Tap **Agree** on the next screen to fully enable the feature and proceed to the Camera screen.

# Camera home screen

Tap the icons to start using your camera and explore the image and video features of your ZenFone.

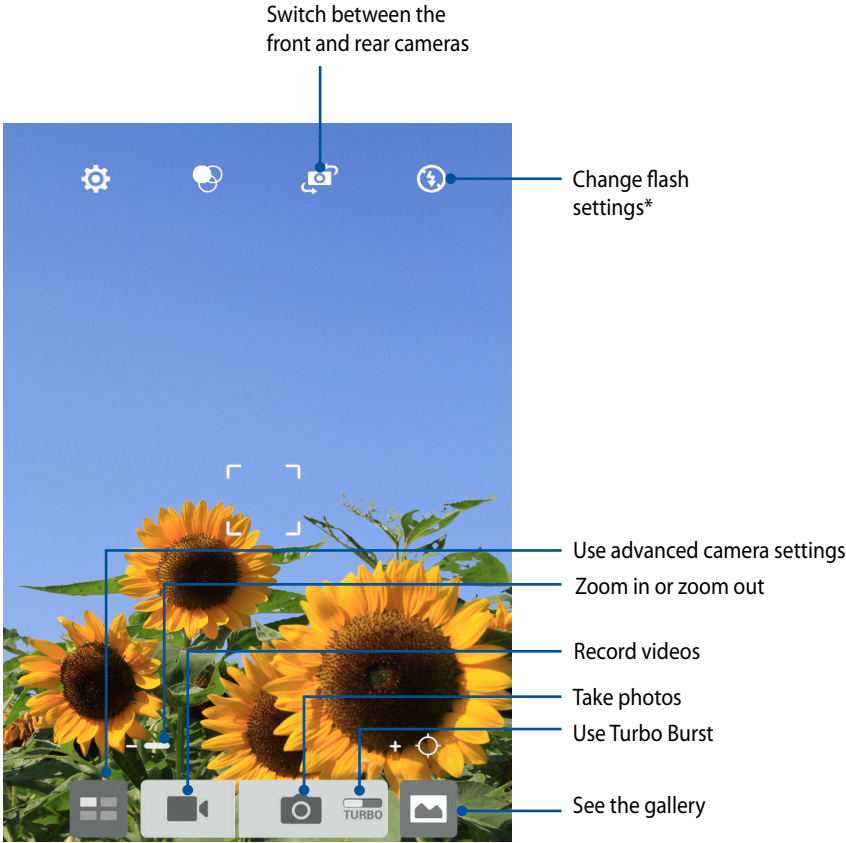

\* on selected models only



## Image settings

Adjust the appearance of your captured images by configuring your camera's settings using the steps below.

---

**IMPORTANT!** Apply the settings first before taking images.

---

1. On the camera's home screen, tap  > .
2. Scroll down and configure the available options.

### Image

Configure the image quality using these options.

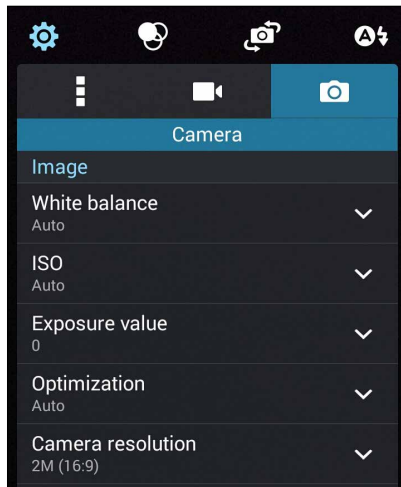

## Shoot mode

Set your shutter speed to **Timer** mode or change the **Burst** speed under this option.

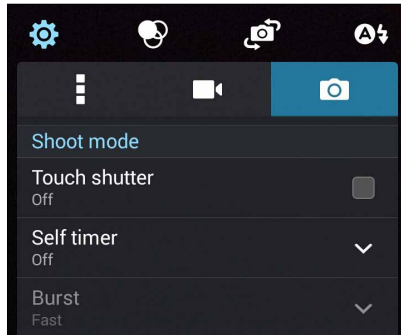

## Focus & exposure

Enable **Touch auto-exposure** or **Face detection** under this option.





## Video settings

Adjust the appearance of your recorded videos by configuring your camera's settings using the steps below.

---

**IMPORTANT!** Apply the settings first before taking images.

---

1. On the camera's home screen, tap  > .
2. Scroll down and configure the available options.

### Image

Configure the video quality using these options.

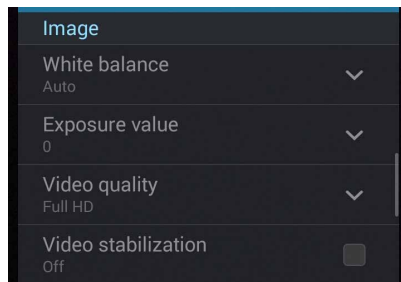

### Focus & exposure

Enable **Touch auto-exposure** under this option.





## Advanced camera features

Explore new ways of capturing images or videos and make captured extra special moments using the advanced camera features of your ZenFone.

---

**IMPORTANT!** Apply the settings first before taking images. Available features may vary per model.

---

### Time Rewind



After selecting **Time Rewind**, your shutter starts taking burst shots two seconds before you actually press the shutter button. As a result, you get a timeline of images where you can choose the best image to save on your Gallery.

---

**NOTE:** The Time Rewind feature can only be used on the rear camera.

---

### Capturing Time Rewind photos

1. From the Camera app's home screen, tap .
2. Tap  > **Time Rewind**.
3. Tap  or the volume key to start capturing photos.

### Using the Time Rewind viewer

1. After pressing the shutter, the Time Rewind viewer appears onscreen on top of a captured photo. Rotate the button on the viewer to browse through the photos you just took.

---

**NOTE:** Tap **Best** to view the best photo suggestion from the timeline.



---

2. Select a photo then tap **Done** to save it to Gallery.

## HDR

The High-dynamic-range (HDR) feature allows you to take more detailed images for low-light and highly contrasting scenes. HDR is recommended for use when taking images on brightly lit locations, helping balance out the colors produced on your image.



### Capturing HDR photos

1. From the Camera app's home screen, tap .
2. Tap  > **HDR**.
3. Tap  or the volume key to start capturing HDR photos.

## Panorama

Capture images from various angles using Panorama. Images captured from a wide angle perspective are automatically stitched together using this feature.

### Capturing panoramic photos

1. From the Camera app's home screen, tap .
2. Tap  > **Panorama**.
3. Tap  or the volume key then pan your ZenFone to the left or right to capture the scenery.

---

**NOTE:** While panning your ZenFone, a timeline of thumbnails appears on the lower part of your screen as it captures the scenery.

---

4. Tap  when finished.

## Night



Take well-lit photos even on night time or on low-light situations using the Night feature of your ZenFone.

---

**NOTE:** Keep your hands steady while before and while the ZenFone is capturing the image to prevent blurry results.

---



### Capturing Night photos

1. From the Camera app's home screen, tap .
2. Tap  > **Night**.
3. Tap  or the volume key to start capturing Night photos.



## Low light

Resolve light issues using the Low light feature of your ZenFone. This feature optimizes the use of burst shots in low-light photography settings.

### Capturing Low light photos

1. From the Camera app screen, tap .
2. Tap  > **Low light**.
3. Tap  or the volume key to start capturing Low light photos.



### Capturing Low light videos

1. From the Camera app screen, tap .
2. Tap  > **Low light**.
3. Tap  or the volume key to start capturing Low light videos.

## Selfie

Take advantage of your rear camera's high megapixel specs without worrying about pressing the shutter button. Using face-detection, you can set your ZenFone to detect up to four faces using the rear camera then automatically capture your selfie or group selfie.







### Capturing Selfie photos

1. From the Camera app screen, tap .
2. Tap  > **Selfie**.
3. Tap  to choose how many people should be included in the photo.
4. Use the rear camera to detect faces and wait for your ZenFone to start beeping, counting down until it captures the photo.
5. The Time Rewind viewer appears onscreen on top of a captured photo. Rotate the button on the viewer to browse through the photos you just took.
6. Select a photo then tap **Done** to save it to Gallery.

## Miniature

Simulate the tilt-shift effect of DSLR lenses via the Miniature feature. Using this feature allows you to focus on specific areas of your subject, adding a bokeh effect that can be used on both photos and video using your ZenFone.





### Capturing Miniature photos

1. From the Camera app screen, tap .
2. Tap  > **Miniature**.
3. Tap  or  to select your focus area.
4. Tap  or  to increase or decrease the background blur.
5. Tap  to capture Miniature photos.

## Smart remove

Eliminate unwanted details immediately after capturing the image using the Smart remove feature.



### Capturing Smart remove photos

1. From the Camera app screen, tap .
2. Tap  > **Smart remove**.
3. Tap  or the volume key to start capturing photos that can be edited using Smart remove.
4. The following screen shows the photo you captured and any removable objects which you may want to delete from it.
5. Tap  to remove the detected objects or  to delete the photo and go back to the Camera app.

## All Smiles

Capture the perfect smile or the wackiest facial expression from a range of photos using the All Smiles feature. This feature lets you take five consecutive photos after pressing the shutter button, automatically detecting faces on the image for comparison.



### Capturing All Smiles photos

1. From the Camera app's home screen, tap .
2. Tap  > **All Smiles**.
3. Tap  or the volume key to start capturing photos that can be edited using All Smiles.
5. Follow the onscreen instructions to select your best photos.

## Beautification

Have fun during and after taking photos of your family and friends using the Beautification feature of your ZenFone. When enabled, this feature allows you to make live beauty enhancements on your subject's face before you press the shutter button.



### Capturing Beautification photos

1. From the Camera app's home screen, tap .
2. Tap  > **Beautification**.
3. Tap  to start capturing photos that can be edited using Beautification features.

## GIF animation

Create GIF (Graphics Interchange Format) images straight from your ZenFone's camera using the GIF animation feature.

### Capturing GIF animation photos



1. From the Camera app's home screen, tap .
2. Tap  > **GIF**.
3. Tap  to start capturing photos that can be transformed into GIF animation.



## Depth of field

Take macro shots with a soft background using the Depth of field. This feature suits close up photos of subjects for a more defined and dramatic result.



### Capturing photos with depth of field

1. From the Camera app screen, tap .
2. Tap  > **Depth of Field**.
3. Tap  or the volume key to start capturing macro photos.

## Time lapse

The time lapse video feature of your ZenFone allows you to capture stills for automatic time lapse playback. In effect, events seem to move in a fast-forward manner though they actually occurred and were recorded between long intervals.

### Recording Time lapse videos

1. From the Camera app's home screen, tap .
2. Tap  > **Time lapse**.
3. Tap  to start taking Time lapse videos.

## Party Link

Enable Party Link and share photos in real-time either by creating a group or joining an existing group. Send and receive freshly captured images among friends, even without internet connection, using this Zen feature.



---

**IMPORTANT!** This feature is only available with devices that also have Party Link.

---

## Sharing photos

To share photos captured straight from your ZenFone's camera:

1. Launch **Camera** then tap .
2. Tap  > **OK**.



- (optional) In the Party Link home screen, set the following items:

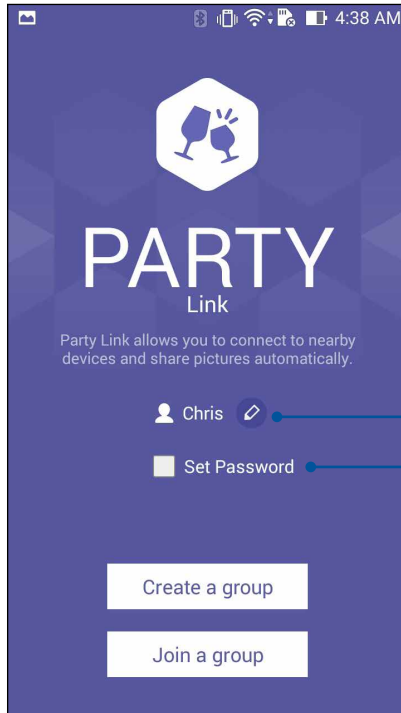

- Tap **Create a group** or **Join a group** to start sharing photos captured from your ZenFone.



---

**IMPORTANT!** If you created a password-protected group, you need to share the password to intended recipients for them to receive your photos.

---

## Receiving photos

To receive photos from other Party Link-enabled devices:

1. Launch **Camera** then tap .
2. Tap  > **OK**.

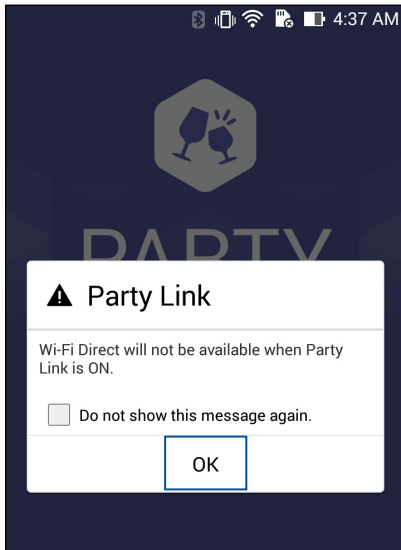

3. Tap **Join a group** > **Scan** to start searching for other Party Link-enabled devices.
4. From the list, tap the group you would like to join then tap **Join**.
5. (optional) If you the group is password-protected, ask the owner for the password to proceed.

7

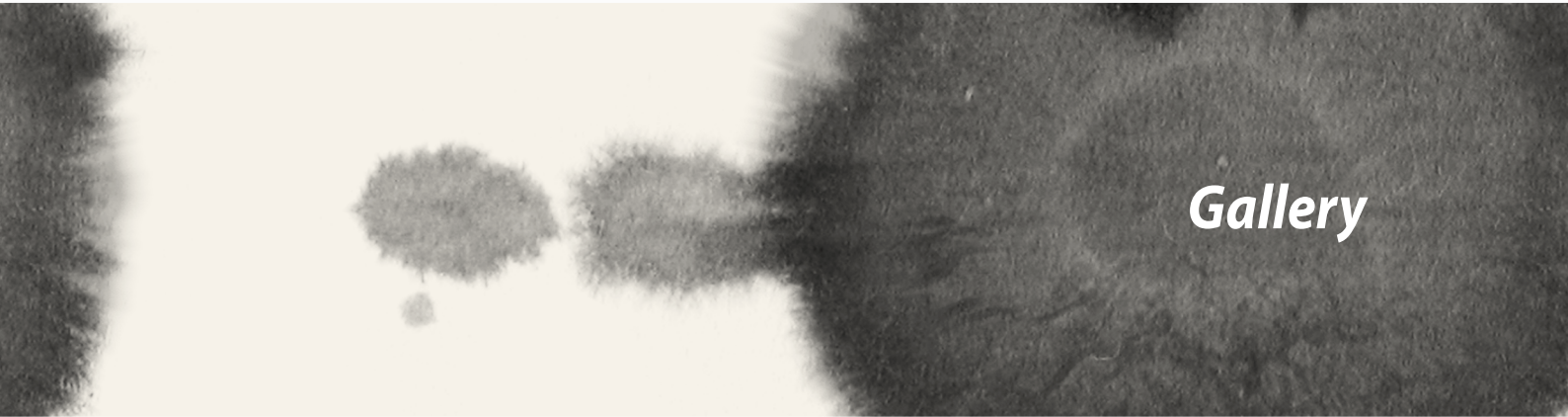

*Gallery*

7

*Gallery*

## Using the Gallery

View images and play videos on your ZenFone using the Gallery app.

This app also allows you to edit, share, or delete image and video files stored in your ZenFone. From Gallery, you can display images in a slideshow or tap to view the selected image or video file.

To launch Gallery, tap  > **Gallery**.

### Main screen

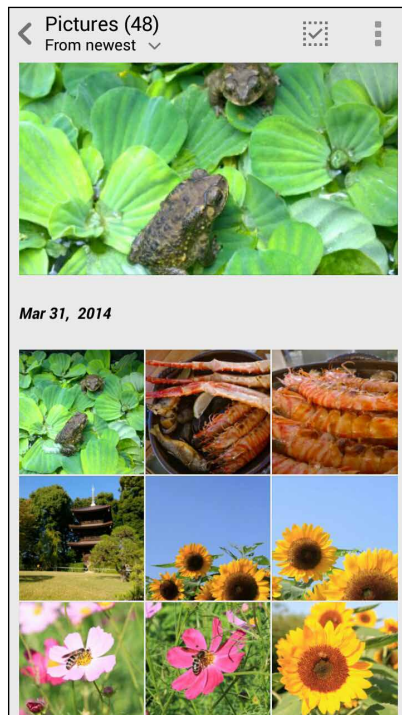

## Viewing files from other source locations

By default, your Gallery displays all the files on your ZenFone according to their album folders.

To view files from other locations accessible via your ZenFone:

1. From the main screen, tap .
2. Tap any of the following source locations to view their respective files.

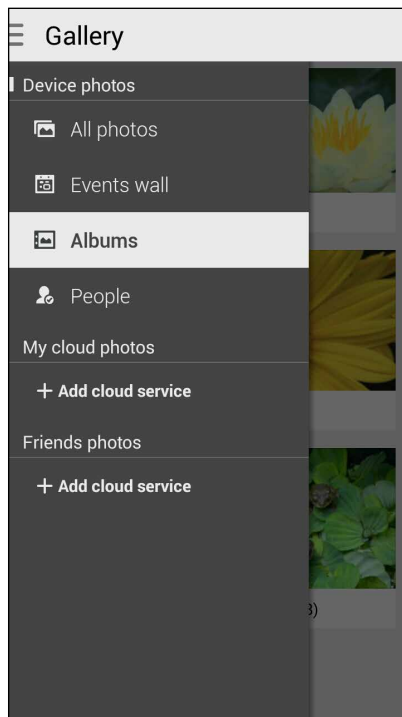



---

**IMPORTANT!** Internet connection is required for viewing photos and videos under **My cloud photos** and **Friends photos**.

---



## Sharing files from the gallery

To share files from the gallery:

1. From the Gallery screen, tap the folder where the files you want to share are located.
2. After opening the folder, tap  to activate file selection.
3. Tap the files you want to share. A check mark appears on top of the image you select.
4. Tap  then select from the list where you want to share the images.

## Deleting files from the gallery

To delete files from the gallery:

1. From the Gallery screen, tap the folder where the files you want to delete are located.
2. After opening the folder, tap  to activate file selection.
3. Tap the files you want to delete. A check mark appears on top of the image you select.
4. Tap .



## Editing an image

The Gallery also features its own image editing tools that you can use to enhance images saved on your ZenFone.

To edit an image:

1. From the Gallery screen, tap the folder where the files are located.
2. After opening the folder, tap the image you want to edit.
3. Once the image is opened, tap it again to show its functions.
4. Tap  to open the image editing toolbar.
5. Tap any of the icons on the editing toolbar to apply changes to the image.

## Zooming in/out the thumbnails or an image

From the Gallery screen or your selected image, spread apart your fingers on the touchscreen panel to zoom out. To zoom in, bring your fingers together on the touchscreen panel.



8



***Work hard, play harder***

8

*Work hard, play harder*

# Supernote

Turn note-taking into a fun and creative activity that syncs with your mobile data using Supernote.

This intuitive app allows you to create notes organized per notebook by directly writing or drawing on the touchscreen. While creating notes, you can also add multimedia files from other apps and share them via social networks or your Cloud storage account.

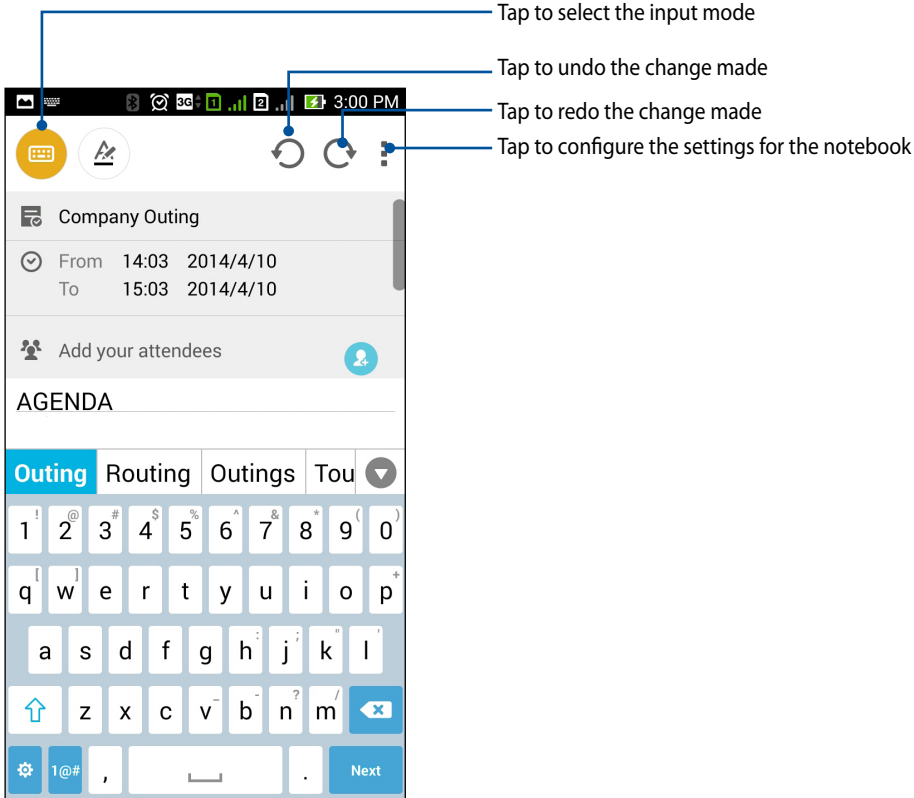

## Understanding icons

Depending on your selected input mode, these icons appear as you take down your notes on SuperNote.



Select this type mode when you want to use the onscreen keyboard to enter your notes.



Select this write mode when you want to scribble or write your notes.



Select this draw mode when you want to create drawings or doodles.



When in draw mode, tap this icon to select the drawing tool to use, and the stroke color or size.



When in draw mode, tap this icon to erase some contents in your notes.



Tap this icon to take a photo or video, record audio, add timestamp and more to your notes.



Tap this icon to add a new page to your notebook.

## Creating a notebook

To create new files using Supernote, refer to the following steps:

1. Tap  > **Supernote**.
2. Tap **Add a new notebook**.
3. Name the file and select Pad or Phone as the page size.
4. Select a template and start writing your notes.

## Sharing a notebook on the Cloud

You may share your notebook on the Cloud using the following steps:

1. On the Supernote home screen, tap-and-hold the notebook you would like to share.
2. In the pop-up screen, tap **Enable cloud sync**.
3. Input your ASUS WebStorage account's User name and Password details to proceed with syncing your notebook to the Cloud.
4. Once the notebook has been successfully synced to the Cloud, the Cloud icon appears on top of the shared notebook.

## Sharing a note to the Cloud

Aside from your notebook, you may also share individual notes from your Supernote to your Cloud storage account. To do this:



1. Launch the notebook that contains the note you want to share.
2. Tap-and-hold the note you want to share.

3. In the pop-up screen, tap **Share** then select the type of file format you want to share it as.
4. In the next screen, select the Cloud storage account where you would like to share your note.
5. Follow the succeeding instructions to complete sharing your selected note.

## Calendar

The Calendar app enables you to keep track of important events using your ZenFone. Along with creating events you may also add notes, set reminders, or create a countdown notice to ensure you don't forget these important occasions.

### Creating an event from your ZenFone

1. Tap  > **Calendar**.
2. Tap **New Event** to start creating a new event.
3. In the New event screen, input all the necessary details of your event.
4. Once finished, tap  to save and exit.

## Adding an account to Calendar

Aside from creating an event logged on your ZenFone, you can also use Calendar to create events that get automatically synced with your online accounts. But first, these accounts must be added to Calendar using the following steps:

1. Launch **Calendar**.
2. Tap  > **Accounts**.
3. Tap the account you want to add.
4. Follow the succeeding onscreen instructions to complete adding the new account to Calendar.

## Creating an event from your account

After adding online accounts that you would like to sync with Calendar, you may now use your ZenFone to create notifications for those online accounts by following these steps:

---

**NOTE:** Your online account must already be added to Calendar before you can proceed with the following steps. You may refer to the *Adding an account to Calendar* section in this e-manual for more details.

---

1. Tap  > **Calendar**.
2. Tap **New Event** to start creating a new event.
3. In the New event screen, tap **My Calendar** to view all the accounts currently synced with the Calendar.
4. Tap the account where you would like to create a new event.
5. In the New event screen, input all the necessary details of your event.



## What's Next

Do not miss out on important events, having fun out in the sun, or getting messages/emails/calls from your favorite people. Set up your calendar of events, Favorites and VIP groups, or weather update settings to get alerts and reminders of what's next. View your What's Next alerts from the Lock screen, Systems Notification panel, and What's Next widget or app.

If you're using **What's Next** for the first time, you would have to set up your calendar account or use the Calendar app in your ZenFone.

---

### NOTES:

- Set up your favorite contacts and VIP groups to receive alerts for missed calls and unread messages or emails from people who matter to you.
  - Get details on creating your calendar of events from the **Calendar** section.
  - Learn how to get weather updates from the **Weather** section.
-

## Do It Later

Get hold of even the most trivial things in your busy life. Even when you're too busy, reply to your emails, SMS messages, calls, or read news online at your convenience.

Mark your unread messages or emails, interesting web pages, and missed calls as **Reply Later**, **Read Later**, or **Call Later** items. These marked items will be added to your Do It Later tasks, and you can act on these tasks at a convenient time.

---

### NOTE:

- Popular third-party apps that support **Do It Later** include Google Maps, Google Chrome, Google Play, YouTube, and IMDb.
  - Not all apps can share and add tasks to **Do It Later**.
-

## Accessing or creating to-do tasks

When you've previously set a message or email as **Reply Later**, or a call as **Call Later**, or a web page as **Read Later**, you can go back to these important message/email/call/web page on the **Do It Later** app.

To access your to-do tasks:

1. From the home screen, tap , then tap **Do It Later** from **All Apps**.
2. Select the task that you want to act on.

To create a new to-task:

From the Do It Later screen, tap  , then proceed to create your to-do task.

# Weather

Get real-time weather updates straight from your ZenFone using the weather app. Using Weather, you can also check other weather details from around the world.

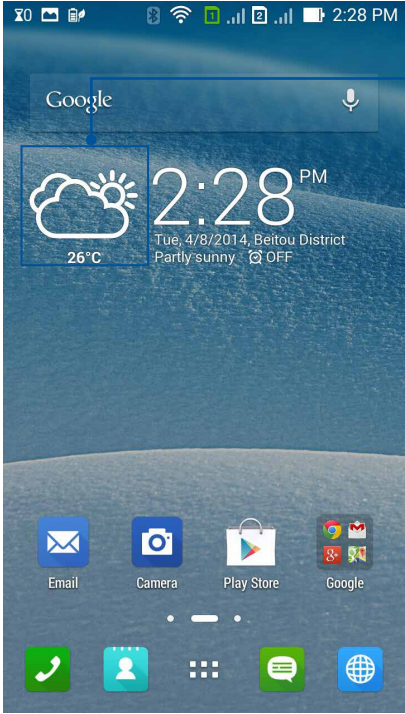

Weather app launcher

## Weather home screen

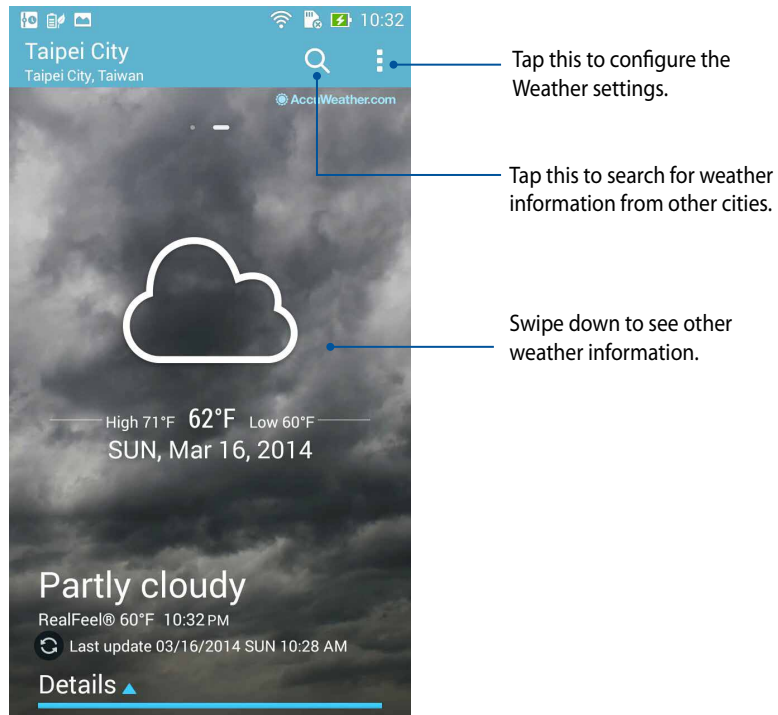

## Clock

Customize the time zone settings of your ZenFone, set alarms, and use your ZenFone as a stop watch using the Clock app.

### Launching Clock

Launch the Clock app using either of the following options:

- From your ZenFone's home screen, tap the digital clock display.

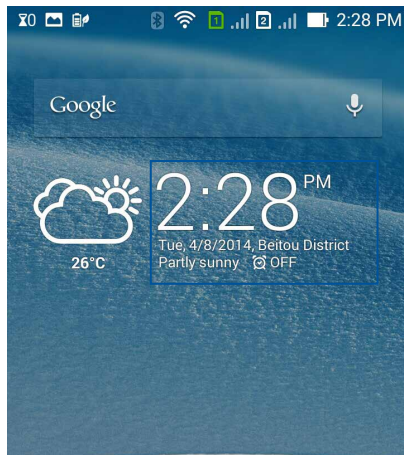

- Tap  > **Clock**.

## World Clock

Tap  to access the world clock settings of your ZenFone.

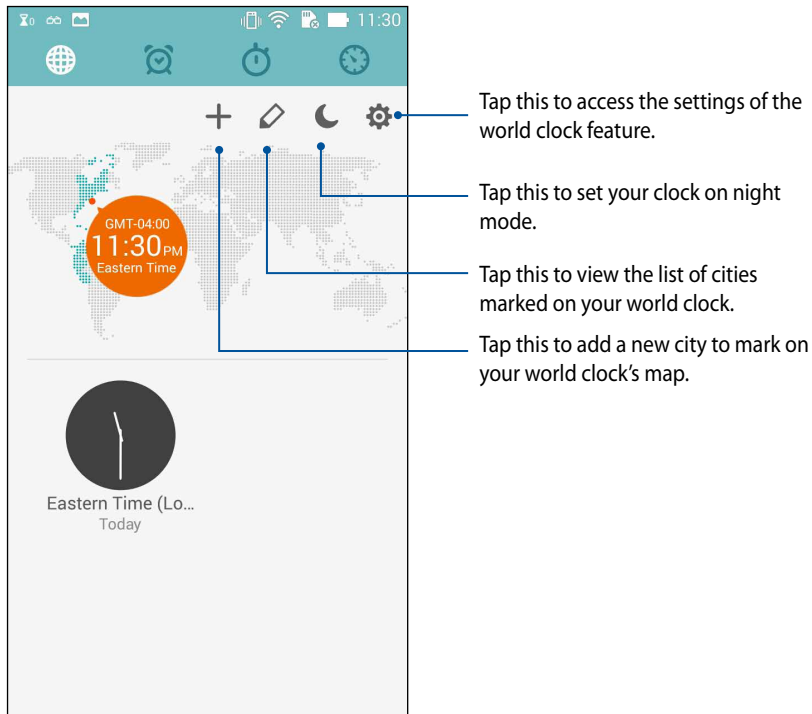

## Alarm clock

Tap  to access the world clock settings of your ZenFone.

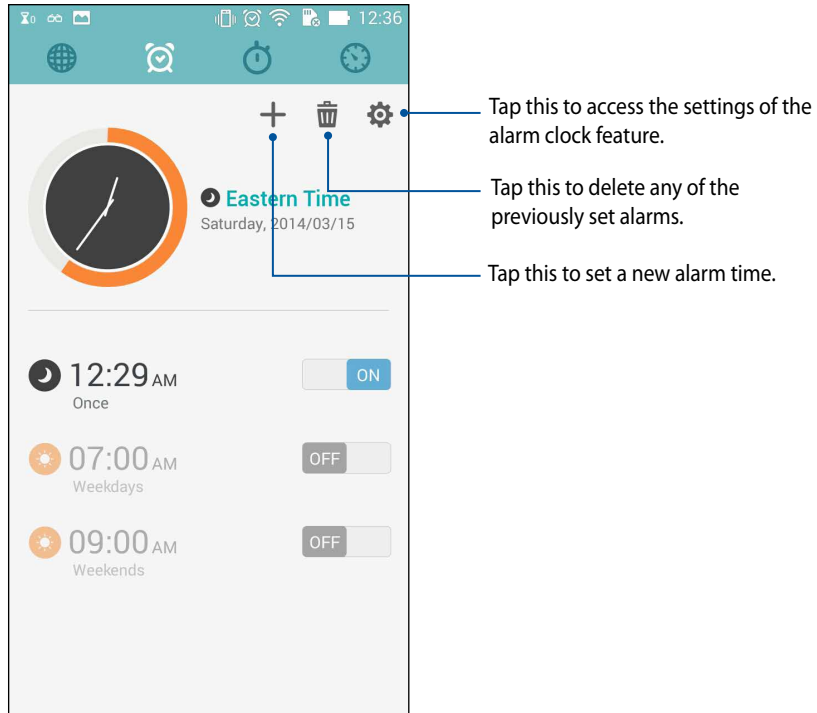



## Stopwatch

Tap  to use your ZenFone as a stopwatch.

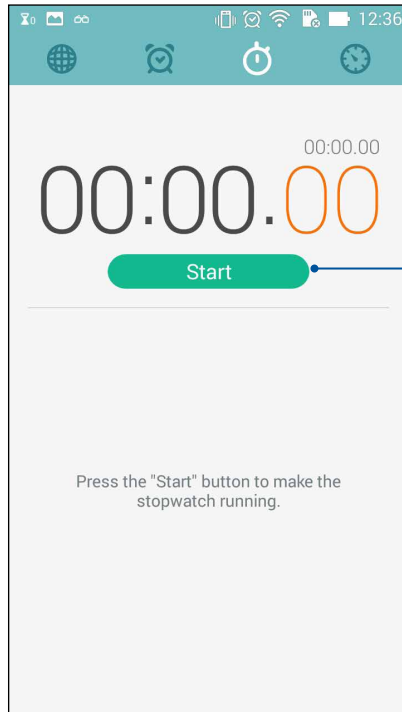

Tap this button to start running the stopwatch feature.

## Timer

You may set multiple timer options for your ZenFone. To do this, follow the steps below:

### Setting the timer

1. Tap  to access the timer feature of your ZenFone.

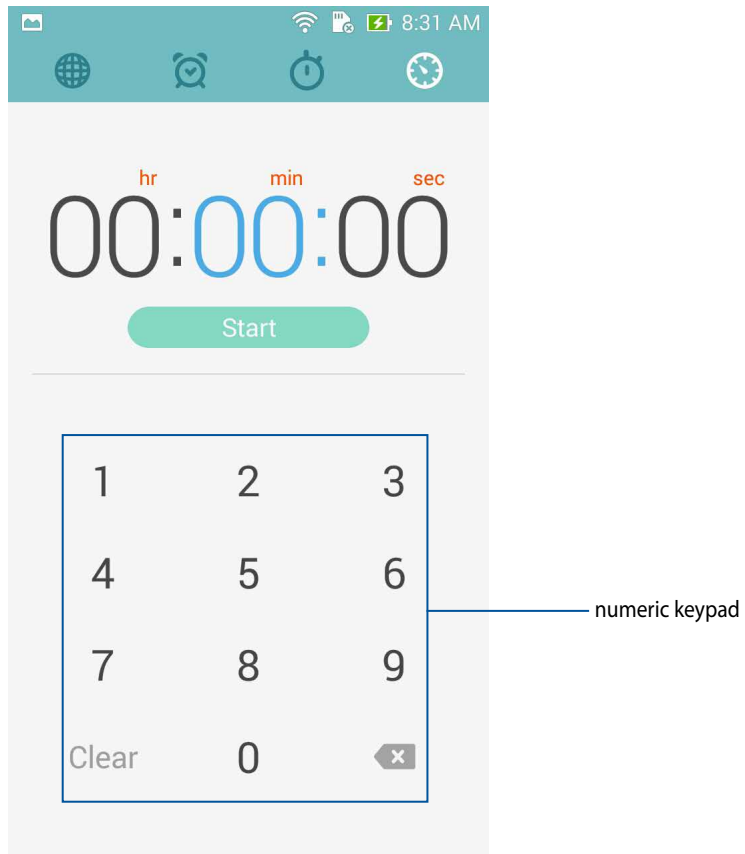

2. Use the numeric keypad to input your target time then tap start to start the timer.

## Adding or deleting timer settings

You may also add new timer settings or delete existing ones that you no longer need. To do any of these options, refer to the following steps:

1. Tap  to access the timer feature of your ZenFone.
2. If you previously created a timer setting, these would appear on your Timer home screen. You may delete or add new timer settings using the icons on your Timer home screen.

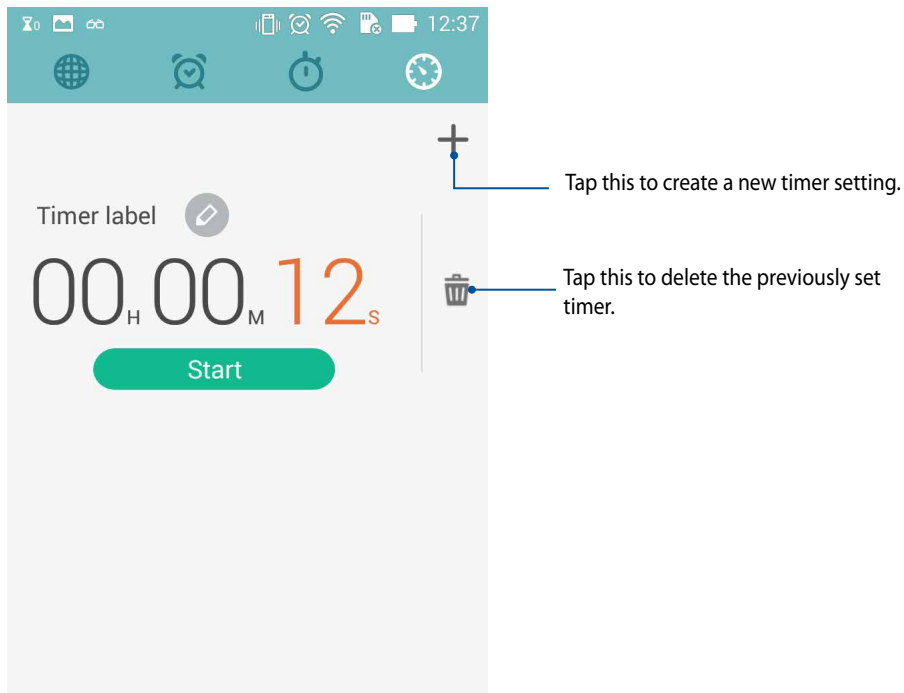



## File Manager

Using File Manager allows you to easily locate and manage your data on the internal storage of your ZenFone and its connected external storage devices.

### Accessing the internal storage

To access the internal storage:

1. Tap  > **File Manager**.
2. Tap  > **Internal storage** to view the contents of your ZenFone then tap an item to select.

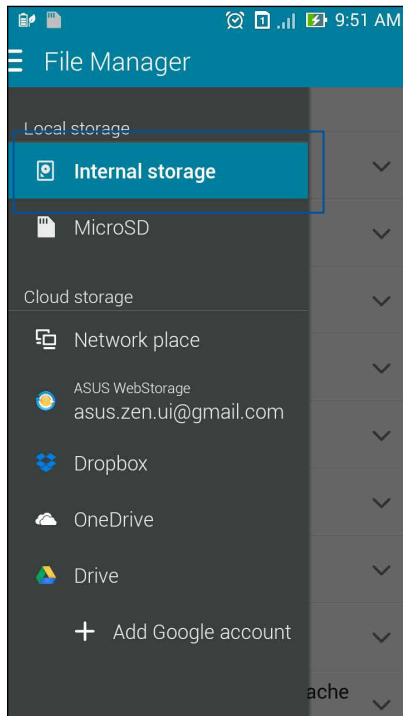

## Accessing the external storage device



To access the external storage device:

1. Insert the microSD card into your ZenFone.

---

NOTE: For more details, refer to the *Installing a memory card* section in this user guide.

---

2. Tap  > **File Manager**.
3. Tap  > **MicroSD** to view the contents of your microSD card.

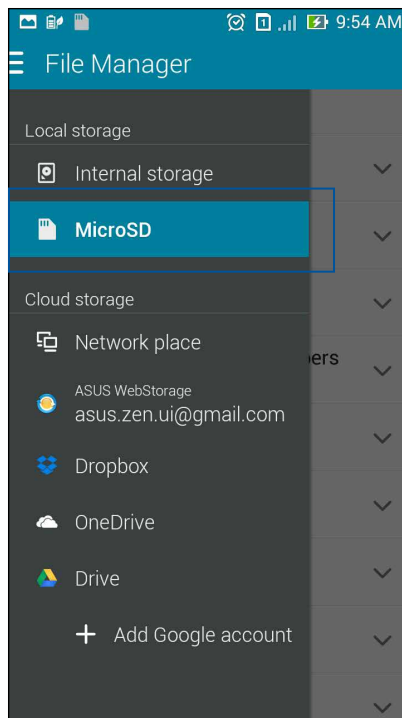



## Accessing Cloud Storage

---

**IMPORTANT!** Enable Wi-Fi on your ZenFone to view files from **Cloud Storage**.

---

To access files saved on your cloud storage accounts:

1. Tap  > **File Manager**.
2. Tap  then tap a cloud storage location under **Cloud Storage**.

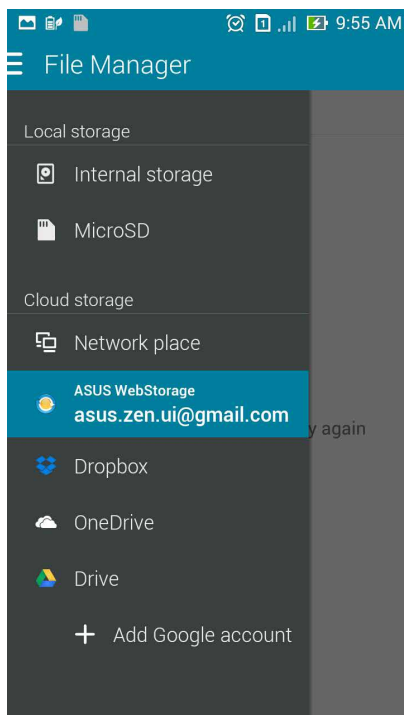

# 9



***The Internet***

## Browser

Your browser's clean and intuitive Zen interface makes it easier to surf web contents at a fast page loading speed via its Chrome-based browser engine. It also lets you share or email web contents, as well as send it as a read later task.

Go to page that you want to share, then tap .

- Tap share a page, tap Share page, then select the account or app where you want to share the page to.
- To send a page for later reading, tap Read later. The page is added a to-do task in your Do It Later app.

---

### NOTES:

- Ensure that your ZenFone is connected to a Wi-Fi or mobile network.
  - If you connect to a mobile network, charges may apply based on your network plan.
  - Refer to section Connecting to a Wi-Fi network for details.
  - Access your to-do tasks from the **Do It Later** app on **All Apps**.
-



# 10

A horizontal strip showing a reflection of a tree in water. The top half of the strip is a dark, textured area representing the tree and its reflection, while the bottom half is a lighter, smoother area representing the water. The text "Fun and entertainment" is overlaid on the right side of the strip.

***Fun and entertainment***

10

*Fun and entertainment*

## Using headset

Have the freedom to do other things while you're in a call or enjoy listening to your favorite music, using a headset.

### Connecting audio jack

Insert the 2.5mm headset jack into the audio port of your device.

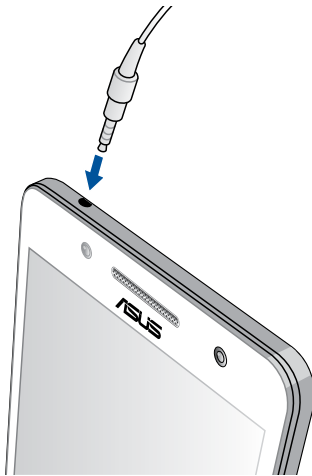

---

#### **WARNING!**

- Do not insert other objects into the audio jack port.
- Do not insert a cable with electric power output into the audio jack port.
- Listening at a high volume for long periods can damage your hearing.

---

#### **NOTES:**

- We highly recommend to use only compatible headsets or the bundled headset with this device.
  - Unplugging the audio jack while listening to music, automatically pauses the music played.
  - Unplugging the audio jack while watching a video, automatically pauses the video playback.
-

## Audio Wizard

AudioWizard allows you to customize the sound modes of your ZenFone for a clearer audio output that fits actual usage scenarios.

### Using Audio Wizard

To use AudioWizard:

1. Tap **ASUS > Audio Wizard**.
2. In the AudioWizard window, tap the sound mode you want to activate then tap **Done** to save and exit.

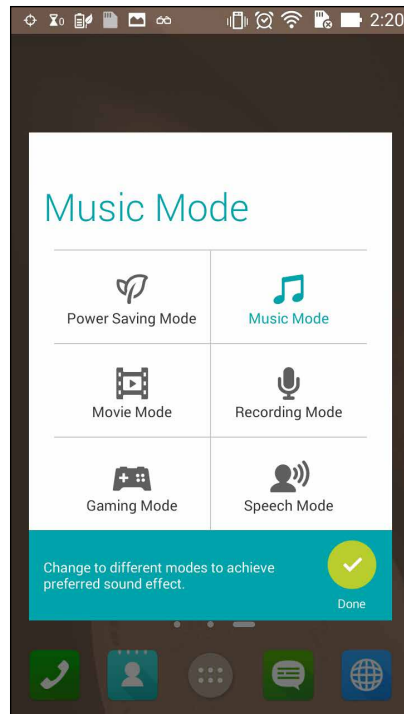

# Play Games

Get the latest games online and share them in your social media accounts using the Play Games app. You can also join multiplayer games and check out leaderboards for some competitive gaming fun.

---

**IMPORTANT!** Log in to your Google account to maximize the features of Play Games.

---

## Using Play Games

To use Play Games:

1. Tap  > **Play Games**.
2. Tap the option you would like to use.

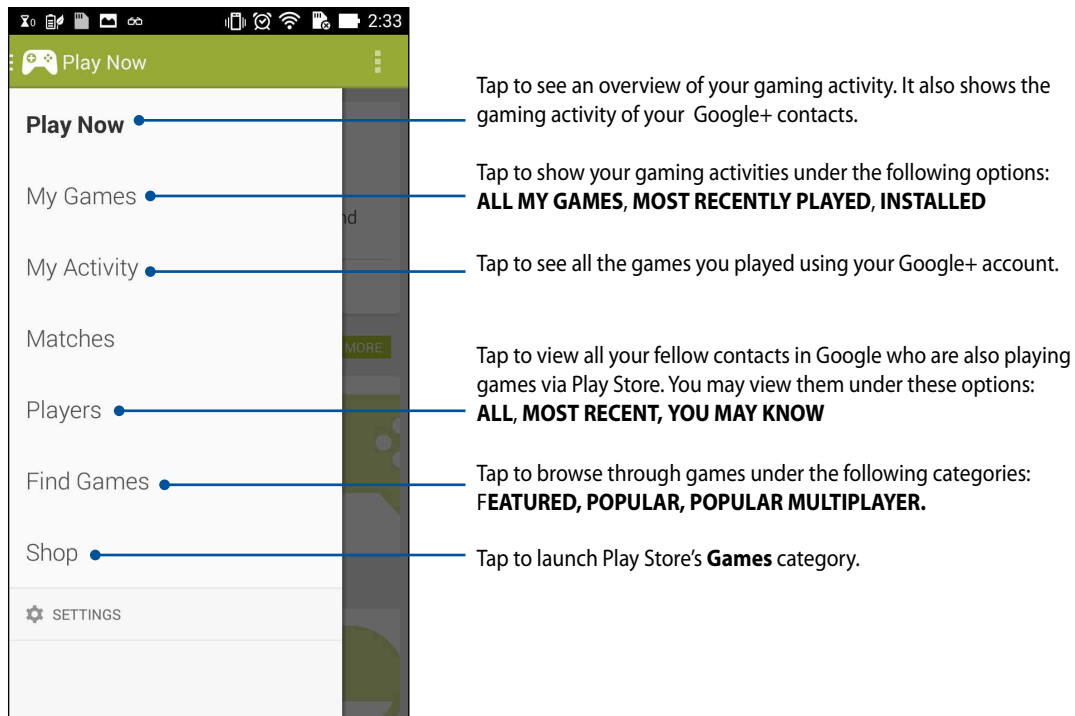

## Music

Access your music collection right on your ZenFone using the Music app. Music allows you to play music files stored internally or from an external storage device.

### Launching Music

To launch Music, tap  > **Music**.

### Playing songs

By default, Music plays all the songs saved in your ZenFone's internal storage system. Start playing songs by tapping on them.

### Playing songs from your SD card

To play songs saved from your SD card:

1. Ensure that your SD card is already inserted in your ZenFone.

---

NOTE: For details on how to install the SD card, refer to the *Insert micro SD card* section in this e-Manual.

---

2. From the Music home screen, tap .
3. Under My Device, tap **Music** to browse through the music files saved in your SD card.

## Playing Cloud music

---

**IMPORTANT!** Enable Wi-Fi on your ZenFone to view files from **Cloud music**.

---

Your ZenFone currently supports music files saved in the following cloud storage accounts:

- ASUS Webstorage
- Dropbox
- OneDrive
- Drive

### Adding a cloud storage account

To play songs saved from any of these cloud storage accounts:

1. From the Music home screen, tap .
2. Under Cloud Music, select **Add cloud service**.
3. Select the cloud storage service where you want to play music files from.
4. Follow the succeeding instructions to complete signing in to your cloud storage account.

### Playing songs from a cloud storage account

1. Launch the Music app then tap .
2. Under Cloud Music, select the cloud storage service you want to play songs from.

## FM Radio

Listen to your favorite local radio stations using your ZenFone.

To use this feature:

1. Connect the bundled headset with your ZenFone.
2. Tap  > **FM Radio**.

### FM Radio home screen

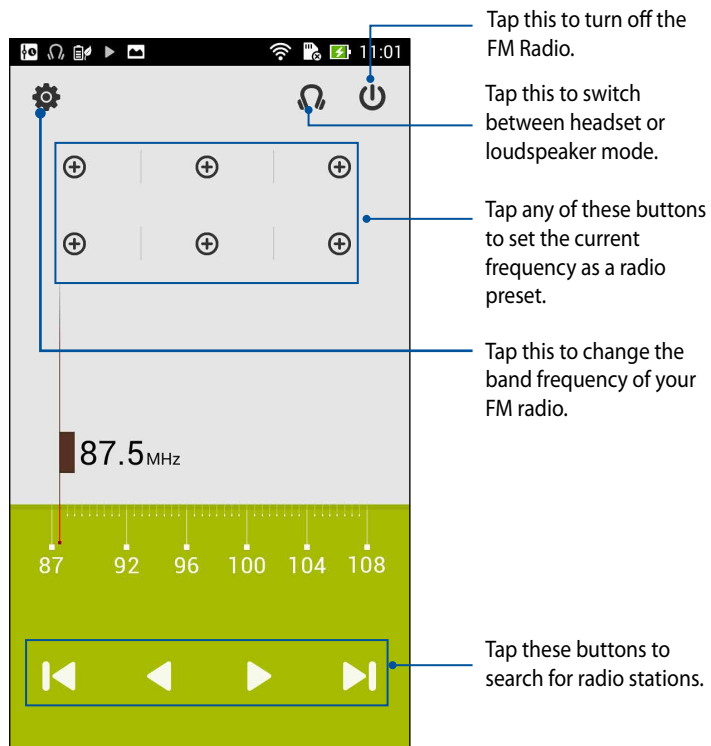

## Sound recorder

Record audio files using your ZenFone by enabling the Sound Recorder app.

### Launching Sound Recorder

To launch Sound Recorder, tap  > **Sound Recorder**.

### Sound Recorder home screen

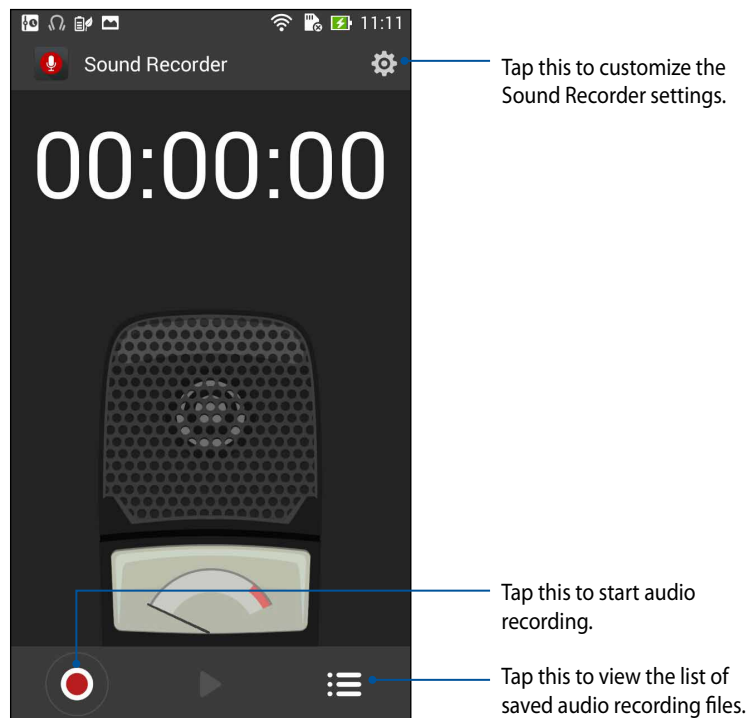



11



*Maintain your Zen*

11

*Maintain your Zen*

## Keeping your device up-to-date

Keep your ZenFone in the loop of Android system updates and upgraded apps and features.

### Updating your system

To update your ZenFone:

1. Tap  then tap **Settings**.
2. On the Settings screen, slide down to display other items then tap **About**.
3. Tap **System update** then tap **Check Update**.

---

**NOTE:** You can preview the last time your ZenFone's system was updated at the **Last update check:** of the **System update** window.

---

## Storage

You can store data, apps, or files on your ZenFone (internal storage), on an external storage, or on an online storage. You need an internet connection to transfer or download your files on an online storage. Use the bundled USB cable to copy files to or from the computer to your ZenFone.

## Backup and reset

Back up data, Wi-Fi passwords, and other settings to Google servers using your ZenFone.  
To do this:

1. Tap  then tap **Settings > Backup and reset**.
2. From the Backup & reset window, you can:
  - **Backup my data:** This feature backs up your data, Wi-Fi passwords, and other settings to Google servers when enabled.
  - **Backup account:** Allows you to specify the account you to be associated when you save your backup.
  - **Automatic Restore:** This feature facilitates restoration of backed up settings and data when you reinstall an app.
  - **Factory data reset:** Erases all data on phone.

## Securing your ZenFone

Use the security features of your ZenFone to prevent unauthorized calls or access of information.

### Unlocking your screen

When the screen is locked, you can open it with the security unlocking options that the ZenFone offers you.

To select the screen unlock of your ZenFone:

1. Tap  then tap **Settings > Lock Screen**.
2. Tap **Screen lock** then select an option to unlock your ZenFone.

---

#### NOTES:

- Refer to section **Unlock screen options** for more information.
  - To deactivate the unlock screen option that you set, tap **None** on Choose screen lock screen.
-

## Unlock screen options

Choose from these options to lock your ZenFone.

- **Slide:** Slide your finger to any direction to unlock your ZenFone.

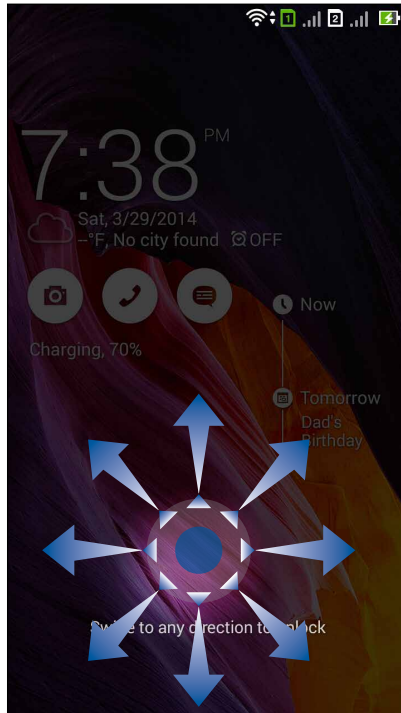

- **Face Unlock:** Show your face on the black window of the lock screen to unlock your ZenFone.
- 

**IMPORTANT!**

- Face Unlock is less secure than a pattern, PIN, or password.
  - Someone who looks similar to you could unlock your ZenFone.
  - The data used to identify your face is kept in your ZenFone.
- 

To set up Face Unlock:

1. From the Choose screen lock screen, tap **Face Unlock**.
  2. Read the terms in using Face Unlock feature on your screen, then tap **Set it up**.
  3. Read the instructions in setting up Face Unlock on your screen, then tap **Continue**.
  4. Hold your ZenFone at eye level and align your face on the outline of your screen to capture it.
- 

**NOTE:** The green-dotted outline indicates that the ZenFone has detected your face and in the process of capturing the image.

---

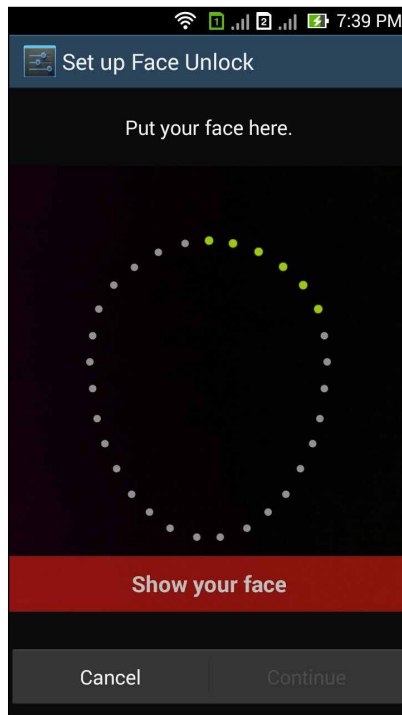

5. After your face has been captured, tap **Continue**.
6. If Face Unlock cannot recognize your face, you will be prompted to select a secondary option to unlock your ZenFone. Select **Pattern** if you want to unlock your ZenFone by a pattern, or **PIN** to unlock it by keying in your PIN then follow the succeeding onscreen instructions.

---

**IMPORTANT!** Ensure to remember the PIN or pattern that you created to unlock your device.

---

7. After you finished Face Unlock setup, tap **OK**.

- **Pattern:** Slide your finger on the dots and create a pattern.

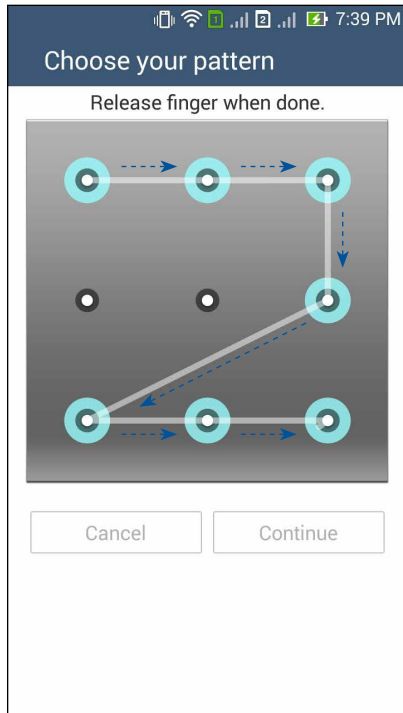

---

**IMPORTANT!** You can create a pattern with a minimum of four dots. Ensure to remember the pattern that you created to unlock your device.

---



- **PIN:** Key in at least four numbers to set a PIN.

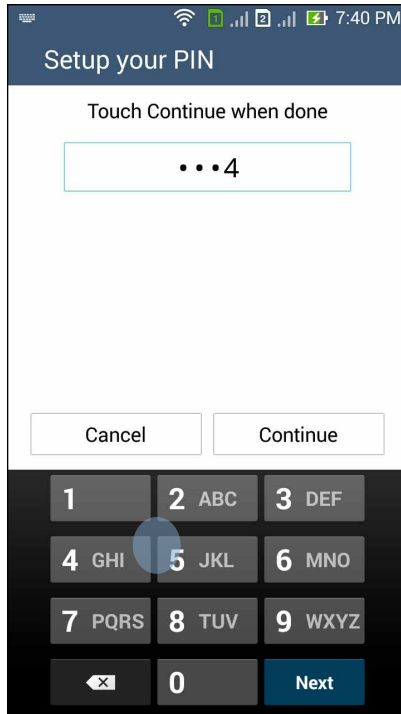

---

**IMPORTANT!** Ensure to remember the PIN that you created to unlock your device.

---

- **Password:** Key in at least four characters to create a password.

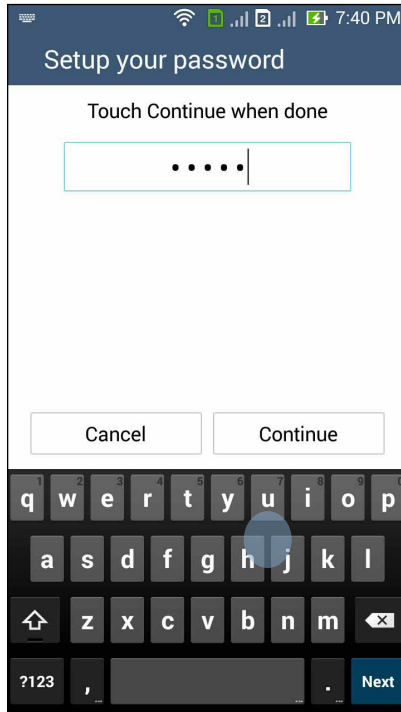

---

**IMPORTANT!** Ensure to remember the password that you created to unlock your device.

---

## Configuring the other screen security features

Aside from the mode of screen lock, you can also do the following on the Screen security window:

- **Quick Access:** Slide the Quick Access switch to **ON** to launch apps on the lock screen.
- **What's Next widget:** Slide the What's Next Widget switch to **ON** to show the said widget on the lock screen.
- **Instant camera:** Slide the Instant camera switch to **ON** to launch the Camera app even if your ZenFone is in idle mode by pressing the volume button twice.
- **Owner info:** Tap this to edit and key in the information that you want to appear even when your screen is locked.

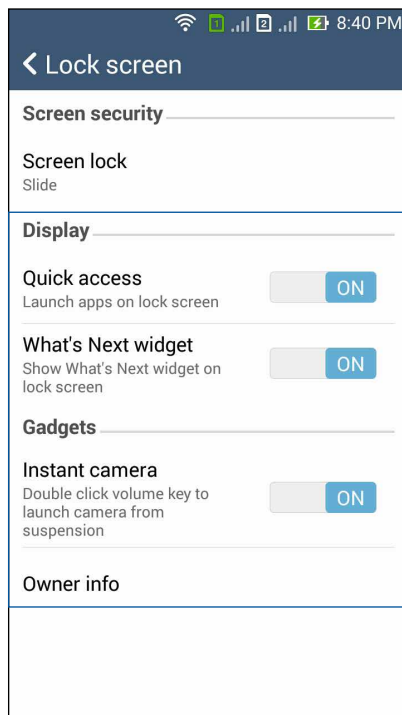

## Setting your ZenFone identity

Know your ZenFone's identity such as serial number, IMEI (International Mobile Equipment Identity) number, or model number.

This is important, as when you may lose your ZenFone, you can contact your mobile carrier and provide the information to blacklist the unauthorized use of your ZenFone.

To display your ZenFone's identity:

1. Tap **All Apps** then tap **Settings**.
2. On the Settings screen, slide down to display other items then tap **About**. The About screen displays the status, legal information, model number, operating system version, hardware, and software information of your ZenFone.
3. To see the serial number, SIM contact number, and IMEI of your ZenFone, tap **Status**.

# 12



***Connect your Zen***

12

*Connect your Zen*

## Wi-Fi

The Wi-Fi technology of your ZenFone gets you connected to the wireless world. Update your social media accounts, browse the Internet, or exchange data and messages wirelessly with your ZenFone.

### Enabling Wi-Fi

To enable Wi-Fi:

1. Tap  on the Home screen then tap **Settings** app.
2. Slide the Wi-Fi switch to the right to turn on the Wi-Fi.

---

**NOTE:** You can also enable the Wi-Fi from Quick Settings screen. Refer to section **Quick Settings** on how to launch Quick Settings screen.

---

### Connecting to a Wi-Fi network

To connect to a Wi-Fi network:

1. On the Settings screen, tap **Wi-Fi** to display all detected Wi-Fi networks.
2. Tap a network name to connect to it. For a secured network, you may be prompted to key in a password or other security credentials.

---

**NOTES:**

- Your ZenFone automatically reconnects to the network that you connected with previously.
  - Turn off Wi-Fi feature to help save battery power.
-

## Disabling Wi-Fi

To disable Wi-Fi:

1. Tap  on the Home screen then tap **Settings** app.
2. Slide the Wi-Fi switch to the left to turn off the Wi-Fi.

---

**NOTE:** You can also disable the Wi-Fi from Quick Settings screen. Refer to section **Quick Settings** on how to launch Quick Settings screen.

---

## Bluetooth®

Use the Bluetooth feature of your ZenFone to send or receive files and stream multimedia files with other smart devices over short distances. With Bluetooth, you can share your media files with your friends' smart devices, send data for print with a Bluetooth printer, or play music files with a Bluetooth speaker.

## Enabling Bluetooth®

To enable Bluetooth:

1. Tap  on the Home screen then tap **Settings** app.
2. Slide the Bluetooth switch to the right to turn on the Bluetooth.

---

**NOTE:** You can also enable the Bluetooth from Quick Settings screen. Refer to section **Quick Settings** on how to launch Quick Settings screen.

---

## Pairing your ZenFone to a Bluetooth® device

Before using the Bluetooth feature of your ZenFone in full scale, you have to pair it first with the Bluetooth device. The ZenFone automatically stores the pairing connection of the Bluetooth device.

To pair your ZenFone to a Bluetooth device:

1. On the Settings screen, tap **Bluetooth** to display all available devices.

---

### **IMPORTANT!**

- If the device that you want to pair is not in the list, ensure to enable its Bluetooth feature and is discoverable.
  - See the user guide that came with your device to learn how to enable its Bluetooth and set it to discoverable.
- 

2. Tap **SEARCH FOR DEVICES** to scan for more Bluetooth devices.
3. In the list of available devices, tap the Bluetooth device that you want to pair with. Follow the succeeding instructions to complete the pairing.

---

**NOTE:** Turn off Bluetooth feature to help save battery power.

---

## Unpairing your ZenFone from the Bluetooth® device

To unpair your ZenFone to a Bluetooth device:

1. On the Settings screen, tap Bluetooth to display all available and paired devices.
2. In the list of paired devices, tap  of Bluetooth device that you want to unpair, then tap **Unpair**.



## Miracast™

Using Miracast technology, you can screencast your ZenFone screen to a Miracast-supported display. Doing this allows an external display to become a dual monitor or second screen to your ZenFone.

### Launching Miracast

There are two ways you can use to start using Miracast from your ZenFone:

#### From Quick settings

1. Setup the Miracast-supported display you want to use with your ZenFone.
2. Launch Quick settings on your ZenFone.
3. On the notification panel, tap **Miracast**.
4. Slide the **Wireless display (Miracast)** option to **ON**.
5. Refer to the SSID shown on your Miracast-supported display and select the same SSID on your ZenFone to start pairing.
6. Once the connection is made, your Miracast-supported display shows the same content currently shown on your ZenFone.

#### From Settings

1. Tap  > **Settings**.
2. Under Device, select **Wireless display (Miracast)**.
3. Set the **Wireless display (Miracast)** option to ON.
4. Refer to the SSID shown on your Miracast-supported display and select the same SSID on your ZenFone to start pairing.
5. Once the connection is made, your Miracast-supported display shows the same content currently shown on your ZenFone.

## Share Link

Share and receive files, apps, or media contents with Android mobile devices using Share Link app (for ASUS mobile devices) or Shareit app (for other mobile devices) via a Wi-Fi connection. With this app, you can send or receive files that are larger than 100 MB and lets you share or receive multiple files at the same time. Share Link app sends and receives files faster than using Bluetooth.

### Sharing files

To share files:

1. From your Home screen, tap  then tap **Share Link**.
2. Tap **Send file** then select from the options that appear on your screen.

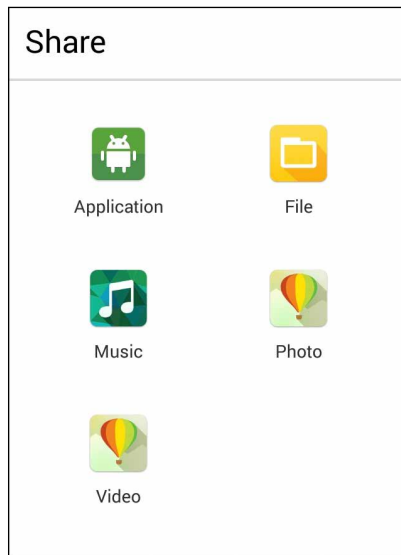

3. Tap the files that you want to send then tap **Done**.
4. After your ZenFone detects the other devices, tap the device that you want to share your files with.



## Receiving files

To receive files:

1. From your Home screen, tap  then tap **Share Link**.
2. Tap **Receive file** to receive the files from the sender.

## The Cloud

Back up your data, sync files among different devices, and share files securely and privately via a Cloud account such as ASUS WebStorage, Drive, OneDrive, and Dropbox.

### ASUS WebStorage

Register for or sign in to ASUS WebStorage and get up to 5GB of free cloud storage account. Automatically upload newly captured photos for instant sharing, sync files among different devices, or share files via your ASUS WebStorage account.

---

**NOTE:** To the enjoy auto-upload function, enable **Instant Upload** from **Settings > Instant Upload** in your ASUS WebStorage.

---

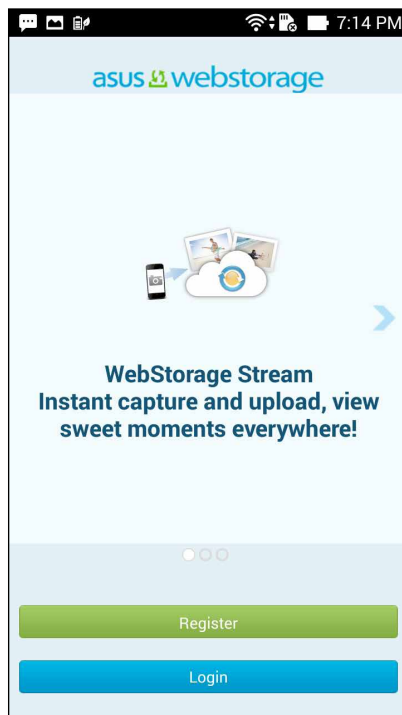

# 13

A horizontal strip showing a reflection of a tree in water. The top half of the strip is a dark, textured area representing the tree's foliage, and the bottom half is a lighter, textured area representing the water's surface. The reflection is centered and slightly blurred.

*App essentials*

13

*App essentials*

## Switching apps

When you've launched several apps on your Zen, you can easily switch between your recently-launched apps.

Tap  to view your recently-launched apps.

- Tap an app to view it.
- To remove an app, simply swipe it to the left or right.

## Locking apps

Secure your apps from unauthorized use with a 4-12 digit password.

To lock your apps:

1. From **All Apps**, tap  > **Lock**.
3. Enter a password containing 4-12 digits, then tap **OK**.

To change the password of your locked apps:

1. From **All Apps**, tap  > **Lock app settings**. Enter your password when prompted.
2. Tap **Change password**, and enter your old and new password.

## Downloading apps

Download tons of apps and games from Play Store directly to your ZenFone. Some of the apps and games are free, others you may need to purchase using a credit card or other payment form.

To download apps:

1. Tap **Play Store** from your Home screen.
2. Follow the onscreen instructions to sign in to your existing Gmail account. If you don't have a Gmail account, please create one.
3. After successfully signing in, you can start downloading an app from Play Store.





14



*There's more to your Zen*

14

*There's more to your Zen*

## Power saver

Fully maximize or extend the power of your ZenFone even when it is idle or while it stays connected to your network. Smartly customize the power settings for your frequent activities such as reading emails or watching videos.

### Setting up Power Saver

Maximize, optimize, or customize the power of your ZenFone with some smart power saving options.

To set up Power Saver:

1. From **All Apps**, tap **Power Saver**.
2. Slide Smart saving to **ON**.

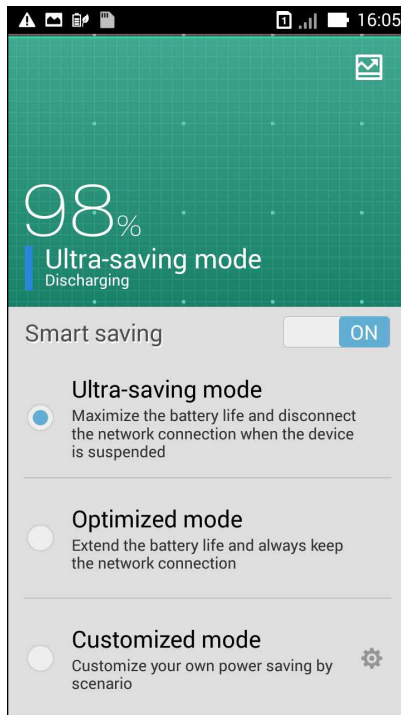

3. Select any of these modes:
  - **Ultra-saving mode:** Disconnects the network connection when your ZenFone is idle to fully maximize its battery life.
  - **Optimized mode:** Extends the battery life while your ZenFone stays connected to your network.
  - **Customized mode:** Allows you to set up the power settings for your frequent activities, and

## Customizing Power Saver

Set the brightness level for your frequent activities such as reading emails or books, watching videos, browsing websites, and listening to music. You can also enable the power saving function for some apps or enable the auto-disconnection of your network when your ZenFone is asleep.

To customize Power Saver:

1. From **Power Saver**, tick **Customized mode**, then tap .
2. Tick an activity, then set the brightness level in percentage.
3. If you want to enable the auto-disconnection of your network, tick **IM and other apps using push notification**. Your ZenFone will automatically disconnect from your network when it is idle, and will resume the network connection when you wake up your ZenFone.

## Glove mode

You can still navigate on the touchscreen of your ZenFone even when you're wearing your gloves.

To enable Glove mode:

1. From the Home screen, tap  > **Settings** > **ASUS customized settings**.
2. Tick **Glove mode**.

## ASUS Splendid

ASUS Splendid allows you to easily adjust the display settings.

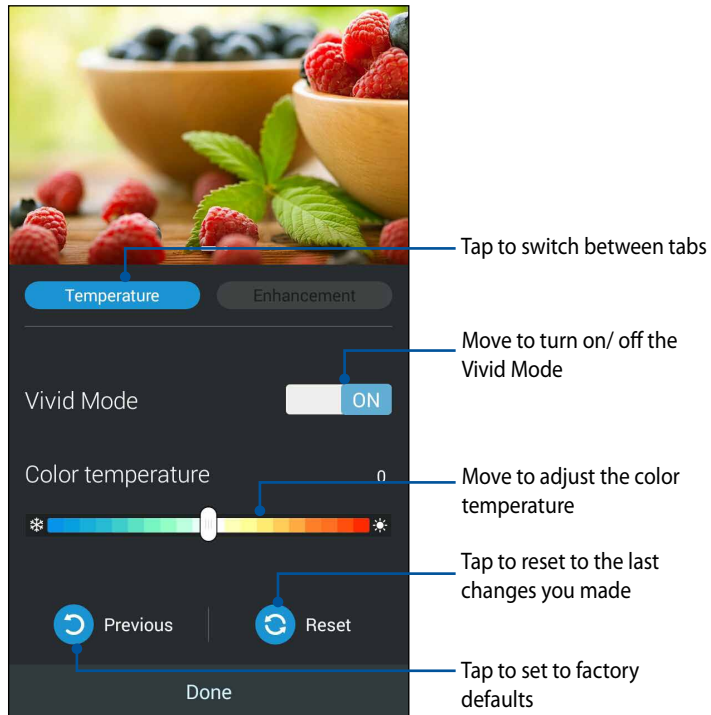

To use ASUS Splendid:

1. Tap  > **ASUS Splendid**.
2. Adjust the screen color temperature and contrast through the **Temperature** and **Enhancement** tabs.
3. Tap **Done** to apply the changes.





*Appendix*

*Appendix*

## Notices

### Federal Communications Commission Statement

This device complies with FCC Rules Part 15. Operation is subject to the following two conditions:

- This device may not cause harmful interference.
- This device must accept any interference received, including interference that may cause undesired operation.

This equipment has been tested and found to comply with the limits for a class B digital device, pursuant to Part 15 of the Federal Communications Commission (FCC) rules. These limits are designed to provide reasonable protection against harmful interference in a residential installation. This equipment generates, uses, and can radiate radio frequency energy and, if not installed and used in accordance with the instructions, may cause harmful interference to radio communications. However, there is no guarantee that interference will not occur in a particular installation. If this equipment causes harmful interference to radio or television reception, which can be determined by turning the equipment off and on, the user is encouraged to try to correct the interference by doing one or more of the following measures:

- Reorient or relocate the receiving antenna.
- Increase the separation between the equipment and receiver.
- Connect the equipment into an outlet on a circuit different from that to which the receiver is connected.
- Consult the dealer or an experienced radio/TV technician for help.

Changes or modifications not expressly approved by the party responsible for compliance could void the user's authority to operate the equipment.

The antenna(s) used for this transmitter must not be co-located or operating in conjunction with any other antenna or transmitter.

Operation on the 5.15-5.25 GHz frequency band is restricted for indoor use only. The FCC requires indoor use for the 5.15-5.25 GHz band to reduce the potential for harmful interference to co-channel Mobile Satellite Systems. It will only transmit on 5.25-5.35 GHz, 5.47-5.725 GHz and 5.725-5.850 GHz bands when associated with an access point (AP).



## RF Exposure Information (SAR)

This device meets the government's requirements for exposure to radio waves. This device is designed and manufactured not to exceed the emission limits for exposure to radio frequency (RF) energy set by the Federal Communications Commission of the U.S. Government.

The exposure standard employs a unit of measurement known as the Specific Absorption Rate, or SAR. The SAR limit set by the FCC is 1.6 W/kg. Tests for SAR are conducted using standard operating positions accepted by the FCC with the EUT transmitting at the specified power level in different channels.

The highest SAR value for the device as reported to the FCC is 1.18 W/kg when placed next to the body.

The FCC has granted an Equipment Authorization for this device with all reported SAR levels evaluated as in compliance with the FCC RF exposure guidelines. SAR information on this device is on file with the FCC and can be found under the Display Grant section of [www.fcc.gov/oet/ea/fccid](http://www.fcc.gov/oet/ea/fccid) after searching on FCC ID: xxxxxxxx.

## Canada, Industry Canada (IC) Notices

This Class B digital apparatus complies with Canadian ICES-003, RSS-210, and CAN ICES-3(B)/NMB-3(B).

Operation is subject to the following two conditions: (1) this device may not cause interference, and (2) this device must accept any interference, including interference that may cause undesired operation of the device. The IC ID for this device is 3568A-K00C.

## Radio Frequency (RF) Exposure Information

The radiated output power of the Wireless Device is below the Industry Canada (IC) radio frequency exposure limits. The Wireless Device should be used in such a manner such that the potential for human contact during normal operation is minimized.

This device has been evaluated for and shown compliant with the IC Specific Absorption Rate ("SAR") limits when installed in specific host products operated in portable exposure conditions.

Canada's REL (Radio Equipment List) can be found at the following web address: <http://www.ic.gc.ca/app/sitt/reltel/srch/nwRdSrch.do?lang=eng>

Additional Canadian information on RF exposure also can be found at the following web address: <http://www.ic.gc.ca/eic/site/smt-gst.nsf/eng/sf08792.html>

## **Canada, avis d'Industrie Canada (IC)**

Cet appareil numérique de classe B est conforme aux normes canadiennes ICES-003, RSS-210 et CAN ICES-3(B)/NMB-3(B).

Son fonctionnement est soumis aux deux conditions suivantes: (1) cet appareil ne doit pas causer d'interférence et (2) cet appareil doit accepter toute interférence, notamment les interférences qui peuvent affecter son fonctionnement. L'identifiant IC de cet appareil est 3568A-K00C.

### **Informations concernant l'exposition aux fréquences radio (RF)**

La puissance de sortie émise par cet appareil sans fil est inférieure à la limite d'exposition aux fréquences radio d'Industrie Canada (IC). Utilisez l'appareil sans fil de façon à minimiser les contacts humains lors du fonctionnement normal.

Ce périphérique a été évalué et démontré conforme aux limites SAR (Specific Absorption Rate – Taux d'absorption spécifique) d'IC lorsqu'il est installé dans des produits hôtes particuliers qui fonctionnent dans des conditions d'exposition à des appareils portables.

Ce périphérique est homologué pour l'utilisation au Canada. Pour consulter l'entrée correspondant à l'appareil dans la liste d'équipement radio (REL - Radio Equipment List) d'Industrie Canada rendez-vous sur: <http://www.ic.gc.ca/app/sitt/reltel/srch/nwRdSrch.do?lang=eng>

Pour des informations supplémentaires concernant l'exposition aux RF au Canada rendez-vous sur: <http://www.ic.gc.ca/eic/site/smt-gst.nsf/eng/sf08792.html>

## IC Warning Statement

The device could automatically discontinue transmission in case of absence of information to transmit, or operational failure. Note that this is not intended to prohibit transmission of control or signaling information or the use of repetitive codes where required by the technology.

The device for the band 5150-5250 MHz is only for indoor usage to reduce potential for harmful interference to co-channel mobile satellite systems; the maximum antenna gain permitted (for device in the bands 5250-5350 MHz and 5470-5725 MHz) to comply with the EIRP limit; and the maximum antenna gain permitted (for devices in the band 5275-5850 MHz) to comply with the EIRP limits specified for point-to-point and non point-to-point operation as appropriate, as stated in section A9.2(3). In addition, high-power radars are allocated as primary users (meaning they have priority) of the band 5250-5350 MHz and this radar could cause interference and/or damage to LE-LAN devices.

The Country Code Selection feature is disabled for products marketed in the US/Canada. For product available in the USA/Canada markets, only channel 1-11 can be operated. Selection of other channels is not possible.

## EC Declaration of Conformity

This product is compliant with the regulations of the R&TTE Directive 1999/5/EC. The Declaration of Conformity can be downloaded from <http://support.asus.com>.

## Prevention of Hearing Loss

To prevent possible hearing damage, do not listen at high volume levels for long periods.



**À pleine puissance, l'écoute prolongée du baladeur peut endommager l'oreille de l'utilisateur.**

For France, headphones/earphones for this device are compliant with the sound pressure level requirement laid down in the applicable EN50332-1:2000 and/or EN50332-2:2003 standard required by French Article L.5232-1.

## CE Mark Warning



### CE marking for devices with wireless LAN/ Bluetooth

This equipment complies with the requirements of Directive 1999/5/EC of the European Parliament and Commission from 9 March, 1999 governing Radio and Telecommunications Equipment and mutual recognition of conformity.

The highest CE SAR value for the device is 0.530 W/Kg.

This equipment may be operated in:

AT	BE	BG	CH	CY	CZ	DE	DK
EE	ES	FI	FR	GB	GR	HU	IE
IT	IS	LI	LT	LU	LV	MT	NL
NO	PL	PT	RO	SE	SI	SK	TR

DFS controls related to radar detection shall not be accessible to the user.

## RF Exposure information (SAR) - CE

This device meets the EU requirements (1999/519/EC) on the limitation of exposure of the general public to electromagnetic fields by way of health protection.

The limits are part of extensive recommendations for the protection of the general public. These recommendations have been developed and checked by independent scientific organizations through regular and thorough evaluations of scientific studies. The unit of measurement for the European Council's recommended limit for mobile devices is the "Specific Absorption Rate" (SAR), and the SAR limit is 2.0 W/Kg averaged over 10 gram of body tissue. It meets the requirements of the International Commission on Non-Ionizing Radiation Protection (ICNIRP).

For next-to-body operation, this device has been tested and meets the ICNRP exposure guidelines and the European Standard EN 62311 and EN 62209-2. SAR is measured with the device directly contacted to the body while transmitting at the highest certified output power level in all frequency bands of the mobile device.

## Power Safety Requirement

Products with electrical current ratings up to 6A and weighing more than 3Kg must use approved power cords greater than or equal to: H05VV-F, 3G, 0.75mm<sup>2</sup> or H05VV-F, 2G, 0.75mm<sup>2</sup>.

## ASUS Recycling/Takeback Services

ASUS recycling and takeback programs come from our commitment to the highest standards for protecting our environment. We believe in providing solutions for you to be able to responsibly recycle our products, batteries, other components as well as the packaging materials. Please go to <http://csr.asus.com/english/Takeback.htm> for detailed recycling information in different regions.

## Coating notice

---

**IMPORTANT!** To provide electrical insulation and maintain electrical safety, a coating is applied to insulate the device except on the areas where the I/O ports are located.

---

## Green ASUS notice

ASUS is devoted to creating environment-friendly products and packaging to safeguard consumers' health while minimizing the impact on the environment. The reduction of the number of the manual pages complies with the reduction of carbon emission.

For the detailed user manual and related information, refer to the user manual included in the ASUS Tablet or visit the ASUS Support Site at <http://support.asus.com/>.

## Regional notice for Singapore

Complies with  
IDA Standards  
DB103778

This ASUS product complies with IDA Standards.

Model name: ASUS\_T00F / ASUS\_T00J

<b>Manufacturer:</b>	ASUSTeK Computer Inc.
<b>Address:</b>	4F, No.150, LI-TE RD., PEITOU, TAIPEI 112, TAIWAN
<b>Authorised representative in Europe:</b>	ASUS Computer GmbH
<b>Address:</b>	HARKORT STR. 21-23, 40880 RATINGEN, GERMANY



## **COPYRIGHT INFORMATION**

No part of this manual, including the products and software described in it, may be reproduced, transmitted, transcribed, stored in a retrieval system, or translated into any language in any form or by any means, except documentation kept by the purchaser for backup purposes, without the express written permission of ASUSTeK COMPUTER INC. ("ASUS").

ASUS PROVIDES THIS MANUAL "AS IS" WITHOUT WARRANTY OF ANY KIND, EITHER EXPRESS OR IMPLIED, INCLUDING BUT NOT LIMITED TO THE IMPLIED WARRANTIES OR CONDITIONS OF MERCHANTABILITY OR FITNESS FOR A PARTICULAR PURPOSE. IN NO EVENT SHALL ASUS, ITS DIRECTORS, OFFICERS, EMPLOYEES OR AGENTS BE LIABLE FOR ANY INDIRECT, SPECIAL, INCIDENTAL, OR CONSEQUENTIAL DAMAGES (INCLUDING DAMAGES FOR LOSS OF PROFITS, LOSS OF BUSINESS, LOSS OF USE OR DATA, INTERRUPTION OF BUSINESS AND THE LIKE), EVEN IF ASUS HAS BEEN ADVISED OF THE POSSIBILITY OF SUCH DAMAGES ARISING FROM ANY DEFECT OR ERROR IN THIS MANUAL OR PRODUCT.

Products and corporate names appearing in this manual may or may not be registered trademarks or copyrights of their respective companies, and are used only for identification or explanation and to the owners' benefit, without intent to infringe.

SPECIFICATIONS AND INFORMATION CONTAINED IN THIS MANUAL ARE FURNISHED FOR INFORMATIONAL USE ONLY, AND ARE SUBJECT TO CHANGE AT ANY TIME WITHOUT NOTICE, AND SHOULD NOT BE CONSTRUED AS A COMMITMENT BY ASUS. ASUS ASSUMES NO RESPONSIBILITY OR LIABILITY FOR ANY ERRORS OR INACCURACIES THAT MAY APPEAR IN THIS MANUAL, INCLUDING THE PRODUCTS AND SOFTWARE DESCRIBED IN IT.

Copyright © 2014 ASUSTeK COMPUTER INC. All Rights Reserved.

## **LIMITATION OF LIABILITY**

Circumstances may arise where because of a default on ASUS' part or other liability, you are entitled to recover damages from ASUS. In each such instance, regardless of the basis on which you are entitled to claim damages from ASUS, ASUS is liable for no more than damages for bodily injury (including death) and damage to real property and tangible personal property; or any other actual and direct damages resulted from omission or failure of performing legal duties under this Warranty Statement, up to the listed contract price of each product.

ASUS will only be responsible for or indemnify you for loss, damages or claims based in contract, tort or infringement under this Warranty Statement.

This limit also applies to ASUS' suppliers and its reseller. It is the maximum for which ASUS, its suppliers, and your reseller are collectively responsible.

UNDER NO CIRCUMSTANCES IS ASUS LIABLE FOR ANY OF THE FOLLOWING: (1) THIRD-PARTY CLAIMS AGAINST YOU FOR DAMAGES; (2) LOSS OF, OR DAMAGE TO, YOUR RECORDS OR DATA; OR (3) SPECIAL, INCIDENTAL, OR INDIRECT DAMAGES OR FOR ANY ECONOMIC CONSEQUENTIAL DAMAGES (INCLUDING LOST PROFITS OR SAVINGS), EVEN IF ASUS, ITS SUPPLIERS OR YOUR RESELLER IS INFORMED OF THEIR POSSIBILITY.

## **SERVICE AND SUPPORT**

Visit our multi-language web site at: <http://support.asus.com>

